

Relay outputs:

Relay functions.....	Setpoint, Window, Sensor error, Latch Power and Off
Hysteresis, in % / display counts	0,1...25% / 1...2999
On and Off delay	0...3600 s
Sensor error detection	Break / Make / Hold
Max. voltage.....	250 VRMS
Max. current	2 A / AC or 1 A / DC
Max. AC power	500 VA

Ex / I.S. approval:

FM, applicable in.....	Class I, Div. 2, Group A, B, C, D Class I, Div. 2, Group IIC Zone 2
Max. ambient temperature for T5	60°C

Marine approval:

Det Norske Veritas, Ships & Offshore	Standard for Certification No. 2.4
--	------------------------------------

GOST R approval:

VNIIM, Cert. no.....	See www.preelectronics.com
----------------------	--

Observed authority requirements:**Standard:**

EMC 2004/108/EC	EN 61326-1
LVD 2006/95/EC.....	EN 61010-1
FM	3600, 3611, 3810 and ISA 82.02.01
UL, Standard for Safety	UL 508

of span = of the currently selected measurement range

Error indications

Readout at hardware error		
Error search	Readout	Error cause
Test of internal CJC sensor	CJ.ER	CJC sensor defect or temperature outside range
Checksum test of the configuration in FLASH	FL.ER	Error in FLASH
Communications test 4501 / 4131	NO.CO	Connection error
Check that input signal matches input configuration	IN.ER	1) Error levels on input
Check that saved configuration in 4501 matches device	TY.ER	Configuration is not 4131

! Error indications in the display flash once per second. The help text explains the error.

1) The error is reset by switching off and then switching on the supply voltage to the device.

BLOCK DIAGRAM

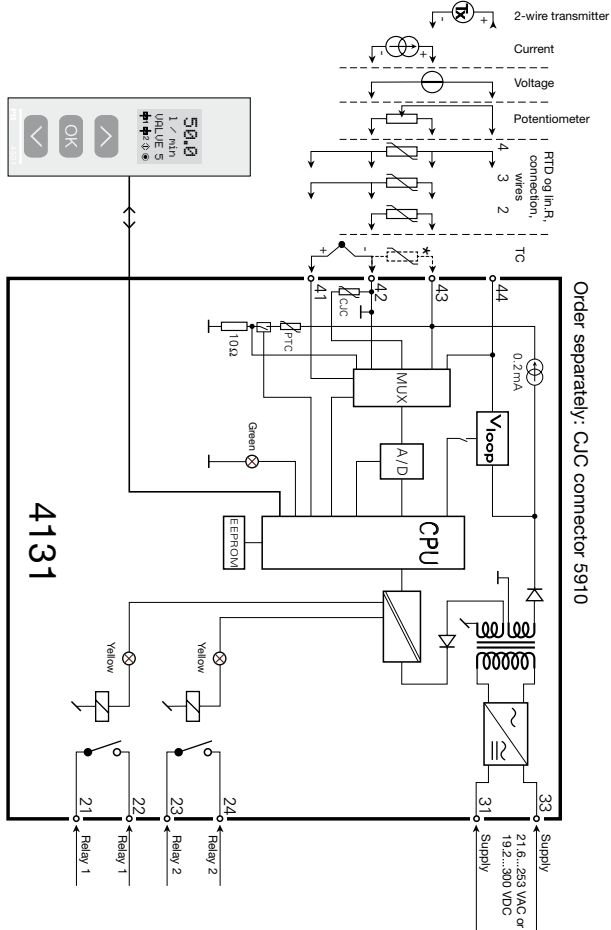

Signal and sensor error info via display front 4501

Sensor error (see limits in the table) is displayed as SE.BR (sensor break) or SE.SH (sensor short). Signals outside the selected range (not sensor error, see table for limits) are displayed as IN.LO indicating low input signal or IN.HI indicating high input signal. The error indication is displayed in line 3 as text and at the same time the backlight flashes. Line 4 of the display is a status line which displays status of relay 1 and relay 2, COM (flashing bullet) indicating correct functioning of 4501 and arrow up/down which indicates tendency readout of the input signal. If the figure 1 or figure 2 flashes, the unit has detected that the setpoint has been exceeded and that the relay is in “delay” mode. When the delay time has passed and the relay makes/breaks, the relay sign either displays or disappears.

Signal and sensor error indication without display front

Status of the unit can also be read from the green LED in the front of the device.

Green flashing LED 13 Hz indicates normal operation.

Green flashing LED 1 Hz indicates sensor error.

Steady green LED indicates internal error.

Relay functions

6 different settings of relay function can be selected.

Setpoint: The unit works as a single limit switch

Window: The relay has a window that is defined by a low and a high setpoint. On both sides of the window the relay has the same status.

Error function: The relay is activated by sensor error.

Power: The relay is activated as long as the power is on.

Off: The relay is deactivated.

Latch: The relay is latched. Only valid for setpoint and window function.

Increasing/decreasing: The relays can be set to activate at increasing or decreasing input signal.

Delay: An ON and an OFF delay can be set on both relays in the range 0...3600 s.

Hysteresis: A hysteresis can be set at 0.1...25% of the span or between 1 and 2999 counts.

Manual deactivation of the latch function

If the relay outputs are activated and thereby latched, it will be indicated in the display. The backlight flashes and the scrolling help text tells you how to deactivate the output. Manual deactivation is carried out by way of the front buttons on the 4501. Use \triangle and ∇ to navigate in the menu and \odot to validate your selection. If the password protection has been activated, the password must be entered in order to access the deactivation menu. See the menu structure on page 29.

Advanced functions

The device gives access to a number of advanced functions which can be reached by answering "Yes" to the point "adv.set".

Display setup: Here you can adjust the brightness contrast and the backlight. Setup of TAG numbers with 6 alphanumeric. Line 3 of the display shows TAG number.

Two-point process calibration: The device can be process-calibrated in 2 points to fit a given input signal. A low input signal (not necessarily 0%) is applied and the actual value is entered via 4501. Then a high signal (not necessarily 100%) is applied and the actual value is entered via 4501. If you accept to use the calibration, the device will work according to this new adjustment. If you later reject this menu point or choose another type of input signal the device will return to factory calibration.

Process simulation function: If you say "yes" to the point "EN.SIM" it is possible to simulate an input signal by means of the arrow keys and thus test the function of the relays. When you finalise the point with \odot , the unit returns to normal mode. The point REL.SIM allows you to activate relay 1 and relay 2 by means of the arrow-keys up/down. You must exit the menu by pressing \odot (no time-out).

Password: Here you can choose a password between 0000 and 9999 in order to protect the device against unauthorised modifications to the configuration. The device is delivered default without password. If you have locked the device with a password by mistake, you can always open the menu by using the master password 2008.

Language: In the menu "lang.setup" you can choose between 7 different language versions of help texts that will appear in the menu. You can choose between UK, DE, FR, IT, ES, SE and DK.

Selection of units

After choosing the input signal type you can choose which process units should be displayed in text line 2 (see table). By selection of temperature input the process value is always displayed in Celsius or Fahrenheit. This is selected in the menu point after selection of temperature input.

CJC

In the CJC menu you can choose between CJC connector and internal cold junction compensation. The CJC connector (PR 5910) must be ordered separately.

Memory

In the memory menu you can save the configuration of the device in the 4501, and then move the 4501 onto another device of the same type and download the configuration in the new device.

ROUTING DIAGRAM

If no key is activated for 1 minute, the display will return to the default state 1.0 without saving configuration changes.

⊕ Increase value / choose next parameter

⊖ Decrease value / choose previous parameter

⊙ Accept the chosen value and proceed to the next menu

Hold ⊙ Back to previous menu / return to menu 1.0 without saving

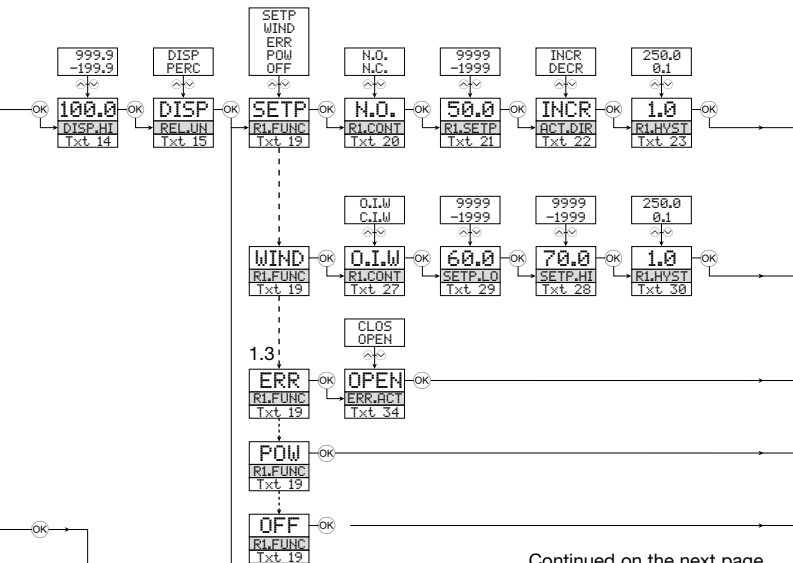

Continued on the next page

Selectable UNITS:

°C	hPa	kW	mA	°F
°F	hPa	kWh	mbar	°F
%	Hz	l	mils	°C
A	in	l/h	min	°C
bar	in/h	l/min	mm	°C
cm	in/min	l/s	mm/s	°C
ft	in/s	m	mol	°C
ft/h	ips	m/h	MPa	°C
ft/min	K	m/min	mV	°C
ft/s	kA	m/s	MW	°C
g	kg	m/s ²	MWh	°C
gal/h	kJ	m ³	N	°C
gal/min	kPa	m ³ /h	Ohm	°C
GW	kV	m ³ /min	Pa	°C
				[blank]

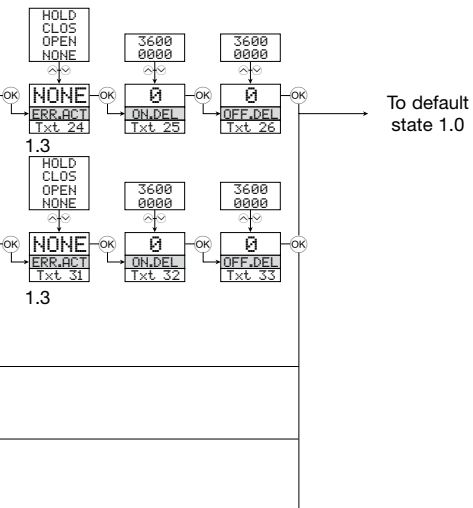

Graphic depiction of relay action setpoint

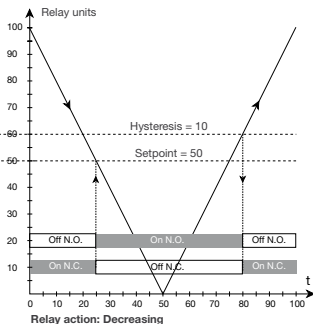
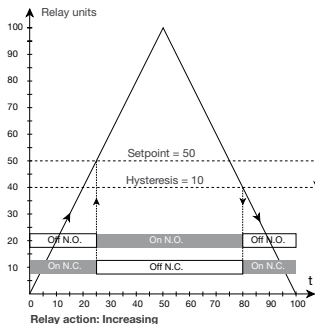

Graphic depiction of relay action window

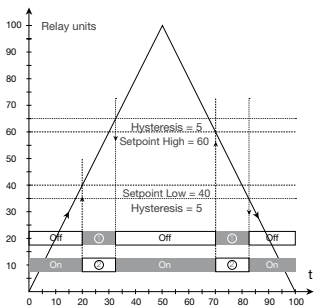

Relay function: Window (shown for increasing signal)

Contact: Closed inside window =

Contact: Open inside window =

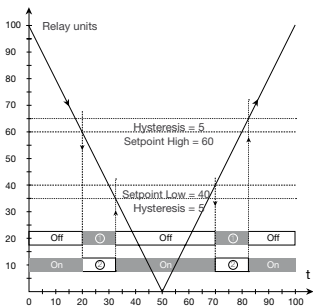

Relay function: Window (shown for decreasing signal)

Contact: Closed inside window =

Contact: Open inside window =



Displays Programmable displays with a wide selection of inputs and outputs for display of temperature, volume and weight, etc. Feature linearisation, scaling, and difference measurement functions for programming via PReset software.



Ex interfaces Interfaces for analogue and digital signals as well as HART® signals between sensors / I/P converters / frequency signals and control systems in Ex zone 0, 1 & 2 and for some modules in zone 20, 21 & 22.



Isolation Galvanic isolators for analogue and digital signals as well as HART® signals. A wide product range with both loop-powered and universal isolators featuring linearisation, inversion, and scaling of output signals.























Temperature A wide selection of transmitters for DIN form B mounting and DIN rail modules with analogue and digital bus communication ranging from application-specific to universal transmitters.



Universal PC or front programmable modules with universal options for input, output and supply. This range offers a number of advanced features such as process calibration, linearisation and auto-diagnosis.



- 
 www.preelectronics.fr
 sales@preelectronics.fr
- 
 www.preelectronics.de
 sales@preelectronics.de
- 
 www.preelectronics.es
 sales@preelectronics.es
- 
 www.preelectronics.it
 sales@preelectronics.it
- 
 www.preelectronics.se
 sales@preelectronics.se
- 
 www.preelectronics.co.uk
 sales@preelectronics.co.uk
- 
 www.preelectronics.com
 sales@preelectronics.com

Head office

Denmark
 PR electronics A/S
 Lerbakken 10
 DK-8410 Rønne

www.preelectronics.com
sales@preelectronics.dk
 tel. +45 86 37 26 77
 fax +45 86 37 30 85



QUALITY SYSTEM AND ENVIRONMENTAL
 MANAGEMENT SYSTEM
 DS/EN ISO 9001
 DS/EN ISO 14001

