

PR
electronics



5 2 0 3 B

**Ex Solenoid /
Alarm Driver**

No. 5203BV105-UK
From ser. no. 040191001



ATEX



- DK** ▶ PR electronics A/S tilbyder et bredt program af analoge og digitale signalbehandlingsmoduler til industriel automation. Programmet består af Isolatorer, Displays, Ex-barrierer, Temperaturtransmittere, Universaltransmittere mfl. Vi har modulerne, du kan stole på i selv barske miljøer med elektrisk støj, vibrationer og temperaturudsving, og alle produkter opfylder de strengeste internationale standarder. Vores motto »Signals the Best« er indbegrebet af denne filosofi - og din garanti for kvalitet.
- UK** ▶ PR electronics A/S offers a wide range of analog and digital signal conditioning devices for industrial automation. The product range includes Isolators, Displays, Ex Interfaces, Temperature Transmitters, and Universal Devices. You can trust our products in the most extreme environments with electrical noise, vibrations and temperature fluctuations, and all products comply with the most exacting international standards. »Signals the Best« is the epitome of our philosophy - and your guarantee for quality.
- FR** ▶ PR electronics A/S offre une large gamme de produits pour le traitement des signaux analogiques et numériques dans tous les domaines industriels. La gamme de produits s'étend des transmetteurs de température aux afficheurs, des isolateurs aux interfaces SI, jusqu'aux modules universels. Vous pouvez compter sur nos produits même dans les conditions d'utilisation sévères, p.ex. bruit électrique, vibrations et fluctuations de température. Tous nos produits sont conformes aux normes internationales les plus strictes. Notre devise »SIGNALS the BEST« c'est notre ligne de conduite - et pour vous l'assurance de la meilleure qualité.
- DE** ▶ PR electronics A/S verfügt über ein breites Produktprogramm an analogen und digitalen Signalverarbeitungsgeräte für die industrielle Automatisierung. Dieses Programm umfasst Displays, Temperaturtransmitter, Ex- und galvanische Signaltrenner, und Universalgeräte. Sie können unsere Geräte auch unter extremen Einsatzbedingungen wie elektrisches Rauschen, Erschütterungen und Temperaturschwingungen vertrauen, und alle Produkte von PR electronics werden in Übereinstimmung mit den strengsten internationalen Normen produziert. »Signals the Best« ist Ihre Garantie für Qualität!

Ex SOLENOID / ALARM DRIVER

PRepower 5203B

Table of contents

Warning.....	2
Symbol identification	3
Safety instructions.....	3
How to demount system 5000	5
Application.....	6
Technical characteristics.....	6
Mounting / installation	6
Application.....	7
Electrical specifications.....	8
DIP-switch programming	10
Connections	11
Block diagram.....	12
Control drawing 5203QU01	14



GENERAL

WARNING

This device is designed for connection to hazardous electric voltages.

Ignoring this warning can result in severe personal injury or mechanical damage.

To avoid the risk of electric shock and fire, the safety instructions of this manual must be observed and the guidelines followed. The specifications must not be exceeded, and the device must only be applied as described in the following.

Prior to the commissioning of the device, this manual must be examined carefully.

Only qualified personnel (technicians) should install this device. If the equipment is used in a manner not specified by the manufacturer, the protection provided by the equipment may be impaired.



**HAZARDOUS
VOLTAGE**

WARNING

Until the device is fixed, do not connect hazardous voltages to the device.

The following operations should only be carried out on a disconnected device and under ESD safe conditions:

Dismantlement of the device for setting of DIP-switches and jumpers.

General mounting, connection and disconnection of wires.

Troubleshooting the device.



Repair of the device and replacement of circuit breakers must be done by PR electronics A/S only.



INSTALLATION

WARNING

To keep the safety distances, the relay contacts on the device must not be connected to both hazardous and non-hazardous voltages at the same time.

SYSTEM 5000 must be mounted on a DIN rail according to DIN 46277.

The communication connector of SYSTEM 5000 is connected to the input terminals on which dangerous voltages can occur, and it must only be connected to the programming unit Loop Link by way of the enclosed cable.

SYMBOL IDENTIFICATION



Triangle with an exclamation mark: Warning / demand. Potentially lethal situations.



The CE mark proves the compliance of the device with the essential requirements of the directives.



The double insulation symbol shows that the device is protected by double or reinforced insulation.



Ex devices have been approved acc. to the ATEX directive for use in connection with installations in explosive areas.

SAFETY INSTRUCTIONS

DEFINITIONS

Hazardous voltages have been defined as the ranges: 75 to 1500 Volt DC, and 50 to 1000 Volt AC.

Technicians are qualified persons educated or trained to mount, operate, and also troubleshoot technically correct and in accordance with safety regulations.

Operators, being familiar with the contents of this manual, adjust and operate the knobs or potentiometers during normal operation.

RECEIPT AND UNPACKING

Unpack the device without damaging it and make sure that the manual always follows the device and is always available. The packing should always follow the device until this has been permanently mounted.

Check at the receipt of the device whether the type corresponds to the one ordered.

ENVIRONMENT

Avoid direct sun light, dust, high temperatures, mechanical vibrations and shock, as well as rain and heavy moisture. If necessary, heating in excess of the stated limits for ambient temperatures should be avoided by way of ventilation.

All devices fall under Installation Category II, Pollution Degree 1, and Insulation Class II.

MOUNTING

Only technicians who are familiar with the technical terms, warnings, and instructions in the manual and who are able to follow these should connect the device.

Should there be any doubt as to the correct handling of the device, please contact your local distributor or, alternatively,

PR electronics A/S
www.prelectronics.com

Mounting and connection of the device should comply with national legislation for mounting of electric materials, i.e. wire cross section, protective fuse, and location. Descriptions of input / output and supply connections are shown in the block diagram and side label.

The following apply to fixed hazardous voltages-connected devices:

The max. size of the protective fuse is 10 A and, together with a power switch, it should be easily accessible and close to the device. The power switch should be marked with a label telling it will switch off the voltage to the device.

Production year can be taken from the first 2 digits of the serial number.

CALIBRATION AND ADJUSTMENT

During calibration and adjustment, the measuring and connection of external voltages must be carried out according to the specifications of this manual. The technician must use tools and instruments that are safe to use.

NORMAL OPERATION

Operators are only allowed to adjust and operate devices that are safely fixed in panels, etc., thus avoiding the danger of personal injury and damage. This means there is no electrical shock hazard, and the device is easily accessible.

CLEANING

When disconnected, the device may be cleaned with a cloth moistened with distilled water.

LIABILITY

To the extent the instructions in this manual are not strictly observed, the customer cannot advance a demand against PR electronics A/S that would otherwise exist according to the concluded sales agreement.

HOW TO DEMOUNT SYSTEM 5000

First, remember to demount the connectors with hazardous voltages.

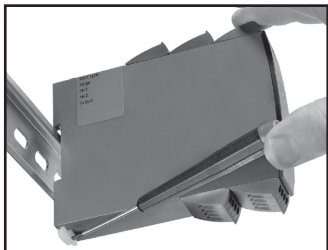

Picture 1:

By lifting the bottom lock, the device is detached from the DIN rail.

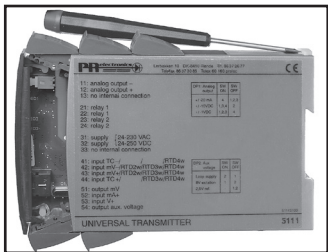

Picture 2:

Then, by lifting the upper lock and pulling the front plate simultaneously the PCB is removed.

Switches and jumpers can now be adjusted.

Ex SOLENOID / ALARM DRIVER

PRepower 5203B

- *1- or 2-channel version*
- *3- / 5-port 3.75 kVAC galvanic isolation*
- *Solenoid driver for Ex area*
- *Digitally controlled voltage supply for Ex area*
- *Universal supply by AC or DC*

Application

- Driver with safety barrier for the control of ON / OFF solenoids mounted in hazardous area.
- Driver with safety barrier for the supply of LEDs and acoustic alarms mounted in hazardous area.
- Voltage supply with ON / OFF control of other equipment.

Technical characteristics

- PR5203B has a digital input per channel for the control of the Ex output voltage.
- Supply, inputs and outputs are floating and galvanically separated.

Mounting / installation

- Mounted vertically or horizontally on a DIN rail. By way of the 2-channel version up to 84 channels can be mounted per metre.

APPLICATION

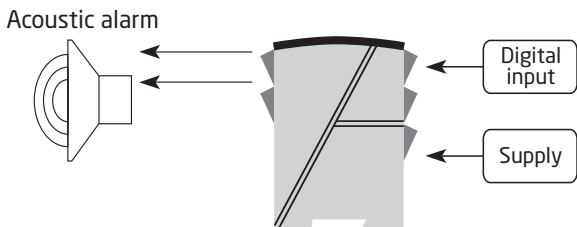
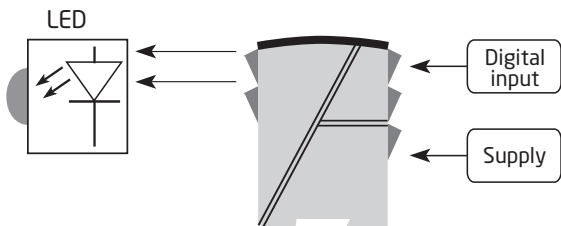
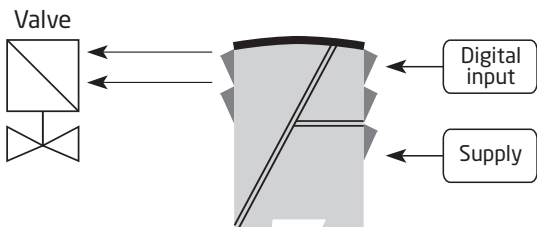

Order: 5203B



Type	Input	Ex barrier	Channels
5203B	PNP : 1	[EEx ia] type : F	Single : 1
	Switch : 2		
	NPN : 3	[EEx ia] type : H	Single : 1
		[EEx ia] type : I	Double : 2

Electrical specifications

Specifications range -20°C to +60°C

Common specifications:

Supply voltage universal 21.6...253 VAC
 50...60 Hz
 19.2...300 VDC

Internal consumption ≤ 2 W (2 channels)

Max. consumption ≤ 4 W (2 channels)

Fuse 400 mA SB / 250 VAC

Isolation voltage, test / operation 3.75 kVAC / 250 VAC

Max. frequency 20 Hz

Calibration temperature 20...28°C

EMC immunity influence < ±0.5% of span

Extended EMC immunity:

NAMUR NE 21, A criterion, burst < ±1% of span

Max. wire size 1 x 2.5 mm² stranded wire

Screw terminal torsion 0.5 Nm

Relative humidity < 95% RH (non-cond.)

Dimensions (HxWxD) 109 x 23.5 x 130 mm

DIN rail type DIN 46277

Protection degree IP20

Weight 230 g

Inputs:**NPN and mechanical switch:**

Trig level LOW	≤ 4.0 VDC
Trig level HIGH	≥ 7.0 VDC
Max. external voltage	28 VDC
Input impedance	3.48 kΩ

PNP:

Trig level LOW	≤ 4.0 V
Trig level HIGH	≥ 7.0 V
Max. external voltage	28 VDC
Input impedance	3.48 kΩ

Outputs:

Output voltage	See Ex data table
Output current	See Ex data table
Output ripple	< 40 mVRMS

EEx / I.S. approvals:

DEMKO 99ATEX126257  II (1) GD

[EEx ia] IIC

Applicable for zone 0, 1, 2, 20, 21 or 22

Ex / I.S. data:

Type:	5203B_F	5203B_H	5203B_I
U _m :	250 V	250 V	250 V
U ₀ :	28 VDC	28 VDC	28 VDC
I ₀ :	115 mADC	110 mADC	93 mADC
P ₀ :	0.81 W	0.77 W	0.65 W
L ₀ :	2 mH	2.6 mH	3 mH
C ₀ :	0.08 µF	0.08 µF	0.08 µF
V _{output} , unloaded min.:	22.0 VDC	22.0 VDC	22.0 VDC
V _{output} , loaded min.:	13.0 VDC	14.0 VDC	10.0 VDC
Output current, max.:	50.0 mADC	35.0 mADC	35.0 mADC

UL IS, Cl. I, Div. 1, Gr. A, B, C, D
 IS, Cl. I, zone 0 and 1, Gr. IIC
 IS, Cl. II, Div. 1, Gr. E, F, G

UL Control Drawing No..... 5203QU01 (Appendix)

GOST R approval:VNIIM & VNIIFTRI, Cert. no. See www.preelectronics.com**Observed authority requirements:**

EMC 2004/108/EC EN 61326-1

LVD 2006/95/EC EN 61010-1

PELV/SELV IEC 364-4-41 and EN 60742

ATEX 94/9/EC EN 50014, EN 50020 and

EN 50281-1-1

UL UL 913, UL 508

DIP-SWITCH PROGRAMMING

Input: (channel 1 = DP 1, channel 2 = DP 2)			
Open collector PNP, direct	Open collector PNP, inverted	Switch and open collector NPN, direct	Switch and open collector NPN, inverted
On Off DP 1 2 3 4	 DP 1 2 3 4	 DP 1 2 3 4	 DP 1 2 3 4

CONNECTIONS

Supply:

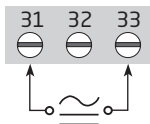

Digital inputs:

Channel 1
Channel 2

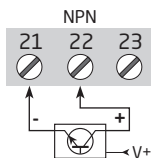
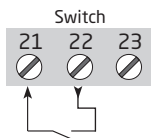
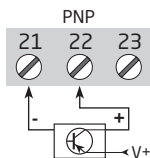
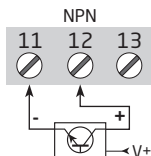
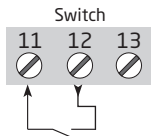
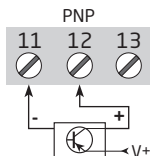

Ex outputs:

Channel 1
Channel 2

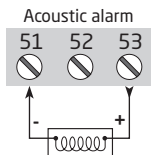
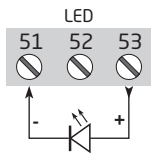
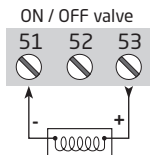
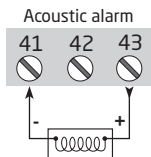
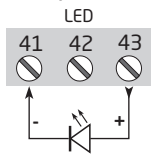
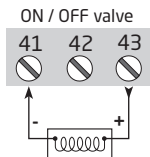

BLOCK DIAGRAM

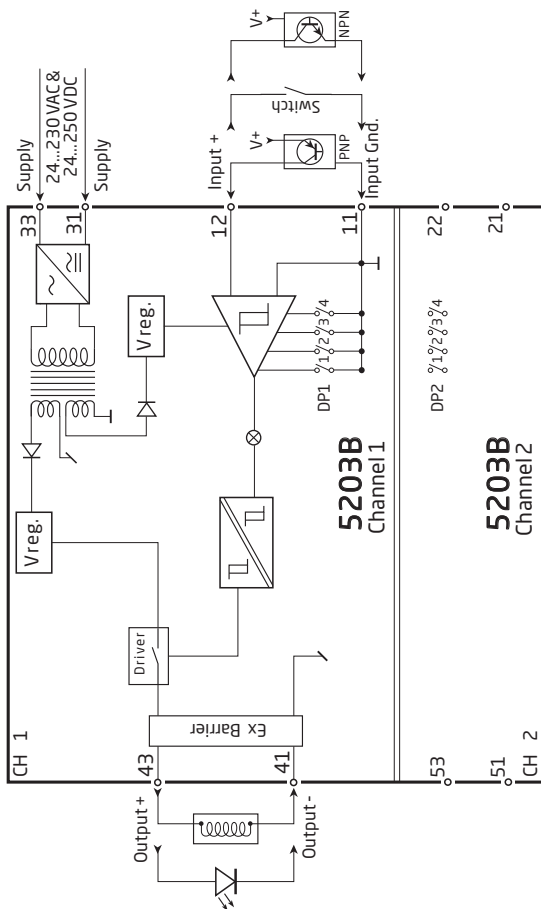

APPENDIX

UL
Control Drawing No.
5203QU01

Control Drawing 5203QU01

Hazardous (Classified) Location

Nonhazardous

Class I, Division 1, Group A,B,C,D
Class I, Zone 0 and 1, Group IIC
Class II, Division 1 Group E, F, G

Associated apparatus
Galvanic Isolated

Intrinsically safe apparatus
entity parameters:

$$V_{\max}(U_i) \geq V_t(U_o)$$

$$I_{\max}(I_i) \geq I_t(I_o)$$

$$P_i \geq P_o$$

$$C_a \geq C_{\text{cable}} + C_i$$

$$L_a \geq L_{\text{cable}} + L_i$$

The sum of capacitance and inductance of cable and intrinsic safe equipment must be less or equal to C_a and L_a

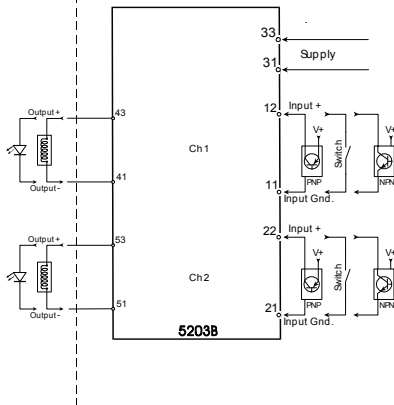

5203B Associated apparatus parameters									
Type	F			H			I		
Vt (Uo)	28 V			28 V			28 V		
It (Io)	115 mA			110 mA			93 mA		
Po	0.81 W			0.77 W			0.65 W		
Group	A, B and IIC	C and IIB	D and IIA	A, B and IIC	C and IIB	D and IIA	A, B and IIC	C and IIB	D and IIA
La (Lo)	1.6 mH	5.0 mH	16mH	2.0 mH	8 mH	20 mH	2.4 mH	9 mH	25 mH
Ca (Co)	0.06 μF	0.52 μF	1.7μF	0.06μF	0.52 μF	1.7μF	0.06 μF	0.52 μF	1.7μF

Installation notes:

- 1) The maximum nonhazardous location voltage is 250Vac/dc.
- 2) The installation shall be in accordance with the National Electrical Code NFPA 70, Articles 504 and 505.
- 3) The terminals of the two individual channels shall not be interconnected in any way.
- 4) Install in Pollution degree 2 or better
- 5) Use 60 / 75 °C Copper Conductors with Wire Size AWG: (26 – 14).
- 6) Warning: Substitution of components may impair intrinsic safety.
- 7) If cable parameters are unknown C_{cable} may be set to 60pF/ft and L_{cable} may be set to 0.20 μH/ft

Rev. AA 2003-09-19



Displays

Programmable displays with a wide selection of inputs and outputs for display of temperature, volume and weight, etc. Feature linearization, scaling, and difference measurement functions for programming via PReset software.



Ex interfaces

Interfaces for analog and digital signals as well as HART® signals between sensors / I/P converters / frequency signals and control systems in Ex zone 0, 1 & 2 and for some devices in zone 20, 21 & 22.



Isolation

Galvanic isolators for analog and digital signals as well as HART® signals. A wide product range with both loop-powered and universal isolators featuring linearization, inversion, and scaling of output signals.



Temperature

























A wide selection of transmitters for DIN form B mounting and DIN rail devices with analog and digital bus communication ranging from application-specific to universal transmitters.



Universal

PC or front programmable devices with universal options for input, output and supply. This range offers a number of advanced features such as process calibration, linearization and auto-diagnosis.



- 
 www.preelectronics.fr
 sales-fr@preelectronics.com
- 
 www.preelectronics.de
 sales-de@preelectronics.com
- 
 www.preelectronics.es
 sales-es@preelectronics.com
- 
 www.preelectronics.it
 sales-it@preelectronics.com
- 
 www.preelectronics.se
 sales-se@preelectronics.com
- 
 www.preelectronics.co.uk
 sales-uk@preelectronics.com
- 
 www.preelectronics.com
 sales-us@preelectronics.com
- 
 www.preelectronics.cn
 sales-cn@preelectronics.com

Head office

Denmark
 PR electronics A/S
 Lerbakken 10
 DK-8410 Rønde

www.preelectronics.com
sales-dk@preelectronics.com
 tel. +45 86 37 26 77
 fax +45 86 37 30 85



QUALITY SYSTEM AND ENVIRONMENTAL MANAGEMENT SYSTEM
 DS/EN ISO 9001
 DS/EN ISO 14001

