

**PR**  
electronics



**2 2 3 1**

**Trip amplifier**

No. 2231V104-UK

Serial no.

980170304-191057000



**EAC CE**

- DK** ▶ PR electronics A/S tilbyder et bredt program af analoge og digitale signalbehandlingsmoduler til industriel automation. Programmet består af Isolatorer, Displays, Ex-barrierer, Temperaturtransmittere, Universaltransmittere mfl. Vi har modulerne, du kan stole på i selv barske miljøer med elektrisk støj, vibrationer og temperaturudsving, og alle produkter opfylder de strengeste internationale standarder. Vores motto »Signals the Best« er indbegrebet af denne filosofi - og din garanti for kvalitet.
- UK** ▶ PR electronics A/S offers a wide range of analog and digital signal conditioning devices for industrial automation. The product range includes Isolators, Displays, Ex Interfaces, Temperature Transmitters, and Multifunctional Devices. You can trust our products in the most extreme environments with electrical noise, vibrations and temperature fluctuations, and all products comply with the most exacting international standards. »Signals the Best« is the epitome of our philosophy - and your guarantee for quality.
- FR** ▶ PR electronics A/S offre une large gamme de produits pour le traitement des signaux analogiques et numériques dans tous les domaines industriels. La gamme de produits s'étend des transmetteurs de température aux afficheurs, des isolateurs aux interfaces SI, jusqu'aux modules universels. Vous pouvez compter sur nos produits même dans les conditions d'utilisation sévères, p.ex. bruit électrique, vibrations et fluctuations de température. Tous nos produits sont conformes aux normes internationales les plus strictes. Notre devise »SIGNALS the BEST« c'est notre ligne de conduite - et pour vous l'assurance de la meilleure qualité.
- DE** ▶ PR electronics A/S verfügt über ein breites Produktprogramm an analogen und digitalen Signalverarbeitungsgeräte für die industrielle Automatisierung. Dieses Programm umfasst Displays, Temperaturtransmitter, Ex- und galvanische Signaltrenner, und Universalgeräte. Sie können unsere Geräte auch unter extremen Einsatzbedingungen wie elektrisches Rauschen, Erschütterungen und Temperaturschwingungen vertrauen, und alle Produkte von PR electronics werden in Übereinstimmung mit den strengsten internationalen Normen produziert. »Signals the Best« ist Ihre Garantie für Qualität!

# TRIP AMPLIFIER

## Type 2231

### CONTENTS

Warning.....	2
Symbol identification .....	3
Safety instructions.....	3
Applications.....	6
Technical characteristics.....	6
Input.....	6
Functions .....	7
Programming .....	7
Display.....	7
Electrical specifications.....	8
Order: 2231.....	10
Block diagram.....	10
Hardware programming.....	11
Routing diagram.....	12
Programming / operation the function keys .....	14
Description of functions (selection of application).....	18



**GENERAL**

## **WARNING**

This device is designed for connection to hazardous electric voltages. Ignoring this warning can result in severe personal injury or mechanical damage.

To avoid the risk of electric shock and fire, the safety instructions of this manual must be observed and the guidelines followed. The electrical specifications must not be exceeded, and the device must only be applied as described in the following.

Prior to the commissioning of the device, this manual must be examined carefully.

Only qualified personnel (technicians) should install this device. If the equipment is used in a manner not specified by the manufacturer, the protection provided by the equipment may be impaired.



**HAZARDOUS  
VOLTAGE**

## **WARNING**

Until the device is fixed, do not connect hazardous voltages to the device. The following operations should only be carried out on a disconnected device and under ESD safe conditions:

Dismantlement of the device for setting of DIP switches and jumpers.

General mounting, connection and disconnection of wires.

Troubleshooting the device.



**Repair of the device and replacement of circuit breakers must be done by PR electronics A/S only.**



**INSTAL-  
LATION**

## **WARNING**

To keep the safety distances, devices with two built-in relays must not be connected to both hazardous and non-hazardous voltages on the same device's relay contacts.

SYSTEM 2200 must be mounted in socket type S3B Releco (order no 7023).

If the device is used with a current transformer, this must be internally protected against disconnection or mounted with an alternative external measuring shunt.

## SYMBOL IDENTIFICATION



**Triangle with an exclamation mark:** Warning / demand. Potentially lethal situations.



**The CE mark** proves the compliance of the device with the requirements of the directives.



**The double insulation** symbol shows that the device is protected by double or reinforced insulation.

## SAFETY INSTRUCTIONS

### DEFINITIONS

Hazardous voltages have been defined as the ranges: 75 to 1500 Volt DC, and 50 to 1000 Volt AC.

**Technicians** are qualified persons educated or trained to mount, operate, and also troubleshoot technically correct and in accordance with safety regulations.

**Operators**, being familiar with the contents of this manual, adjust and operate the knobs or potentiometers during normal operation.

### RECEIPT AND UNPACKING

Unpack the device without damaging it. The packing should always follow the device until this has been permanently mounted. Check at the receipt of the device whether the type corresponds to the one ordered.

### ENVIRONMENT

Avoid direct sunlight, dust, high temperatures, mechanical vibrations and shock, as well as rain and heavy moisture. If necessary, heating in excess of the stated limits for ambient temperatures should be avoided by way of ventilation.

All devices fall under Installation Category II, Pollution Degree 1, and Insulation Class II.

### MOUNTING

Only technicians who are familiar with the technical terms, warnings, and instructions in the manual and who are able to follow these should connect the device.

**Should there be any doubt as to the correct handling of the device, please contact your local distributor or, alternatively,**

**PR electronics A/S  
[www.prelectronics.com](http://www.prelectronics.com)**

Mounting and connection of the device should comply with national legislation for mounting of electric materials, i.a. wire cross section, protective fuse, and location. Descriptions of Input / Output and supply connections are shown in the block diagram and side label.

The following apply to fixed hazardous voltages-connected devices:

The max. size of the protective fuse is 10 A and, together with a power switch, it should be easily accessible and close to the device.

The power switch should be marked with a label telling it will switch off the voltage to the device.

### **CALIBRATION AND ADJUSTMENT**

During calibration and adjustment, the measuring and connection of external voltages must be carried out according to the specifications of this manual.

The technician must use tools and instruments that are safe to use.

### **NORMAL OPERATION**

Operators are only allowed to adjust and operate devices that are safely fixed in panels, etc., thus avoiding the danger of personal injury and damage. This means there is no electrical shock hazard, and the device is easily accessible.

### **CLEANING**

When disconnected, the device may be cleaned with a cloth moistened with distilled water.

### **LIABILITY**

To the extent the instructions in this manual are not strictly observed, the customer cannot advance a demand against PR electronics A/S that would otherwise exist according to the concluded sales agreement.

## HOW TO DISMANTLE SYSTEM 2200

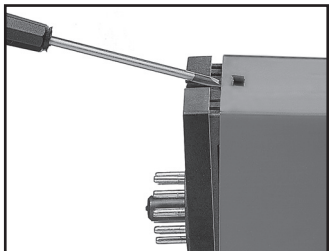

**Picture 1:**

The back panel of the device is detached from the housing by way of a screw-driver.

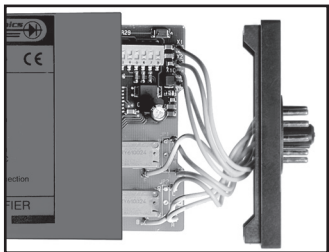

**Picture 2:**

After this, the back panel can be pulled out together with the PCB, but please notice the position of the PCB as there is a number of different positions in the house. Do not pull the wires unnecessarily, instead pull the PCB. Switches and jumpers can now be moved. When assembling the back plate and housing, please make sure no wires are stuck.

# TRIP AMPLIFIER 2231

- AC/DC trip amplifier
- 2 adjustable alarm limits
- Galvanically isolated 3.75 kVAC
- Front programmable
- 3-digit LED display
- 24 VDC or universal supply

## Applications

Alarm detector in connection with measurement of AC/DC current or voltage signals. The unit is used where accurate setpoint setting and different alarm functions are required.

The unit can be used as a single or dual trip amplifier.

Alarm detector can be installed in PELV and SELV circuits.

## Technical characteristics

### General

The unit is microprocessor-based, which allows a very accurate setting of process parameters. Each unit is supplied with basic calibration data, which eliminate the tolerances in the component data. This means that the input can be programmed to the requested signal range without re-adjustment.

Measurement ranges less than the min. measurement range of 0.5 V down to 10 mV may be entered, though this will affect the resolution and the response time. Please note that the electric specifications of the device are only kept as long as the stated min. measurement ranges and max. zero offsets are not exceeded.

### Input

Standard DC current signals in the range 0...20 mA.

The current signal is detected by a 50  $\Omega$  shunt, which is manually connected through an internal jumper.

DC voltage signals in the range 0...250 VDC.

By measurement of AC current signals up to 1 A from a current transformer or current clamp a 1  $\Omega$  / 2 W input shunt is used.

True RMS measurement of AC voltage signals in the range 0...250 VRMS, with a crest factor < 5.



## Functions

The front-operated push buttons are used for programming of the different standard functions.

Single or dual trip amplifier can be selected. Dual trip amplifier with relay 2 as pre-setpoint, single or dual trip amplifier with hysteresis in each relay, which is set as setlow or sethigh and dual trip amplifier with hold on relay 2 until relay 1 is activated.

Make or break function can be selected by an internal jumper.

## Programming

The front keys are used for selection of function and for setting all other parameters like setpoint, reset, active relay for increasing or decreasing signal, delay, and input signal.

The arrow keys are used as hotkeys if a quick change of setpoint is required. If the setpoint is changed, the resetpoint follows, so the selected hysteresis is conserved. A password can prevent access for changing parameters.

## Display

During normal operation the 3-digit display shows the input signal in %. All programmed parameters can be shown by using the front-operated push buttons (see the routing diagram).

## Electrical specifications

Specifications range ..... -20°C to +60°C

### Common specifications:

Supply voltage, DC ..... 19.2...28.8 VDC

Supply voltage, AC and DC ..... 21.6...253 VAC, 50...60 Hz or  
19.2...300 VDC

Internal consumption, 2231D ..... 1.5 W

Internal consumption, 2231P ..... 2 W

Isolation voltage, test / operation ..... 3.75 kVAC / 250 VAC

Signal dynamics, input ..... 16 bit

Response time, program. DC / AC ..... 0.25 / 0.75...60 s

Calibration temperature ..... 20...28°C

### Temperature coefficient:

DC signals ..... < ±0.01% of span /°C

AC signals ..... < ±0.02% of span /°C

### Linearity error:

DC signals ..... < ±0.1% of span

AC sine-wave signals ..... < ±0.35% of span

50...1000 Hz

### Additional linearity error, AC signals

Crest factor 1 - 3 ..... ±0.7% of span

Crest factor 5 ..... ±2.5% of span

Effect of supply voltage change ..... < ±0.002% of span /%V

EMC immunity influence ..... < ±0.5%

Humidity ..... < 95% RH (non-cond.)

Dimensions (HxWxD) ..... 84.5 x 35.5 x 80.5 mm (excl. pins)

Protection degree ..... IP50

Weight 2231 D / 2231 P ..... 125 g / 175 g

Vibration ..... IEC 60068-2-6 : 2007

2...13.2 Hz ..... ±1 mm

13.2...100 Hz ..... ±0.7 g

### Electrical specifications - INPUT:

#### DC current input:

Measurement range ..... 0...20 mA

Min. measurement range (span) ..... 10 mA

Max. offset ..... 50% of selected max. value

Input resistance ..... 50 Ω

Updating time ..... 100 ms

**AC current input:**

Measurement range.....	0...1 ARMS
Min. measurement range (span) .....	0.5 ARMS
Max. offset .....	50% of selected max. value
Input resistance.....	1 $\Omega$ / 2 W
Updating time .....	100 ms

**Voltage input:****DC voltage input:**

Measurement range.....	0...250 VDC
Min. measurement range (span) .....	0.5 VDC
Max. offset .....	50% of selected max. value
Input resistance.....	Nom. 5 M $\Omega$
Updating time .....	100 ms

**AC voltage input:**

Measurement range.....	0...250 VRMS
Min. measurement range (span) .....	0.5 VRMS
Max. offset .....	50% of selected max. value
Input resistance.....	Nom. 5 M $\Omega$
Updating time .....	100 ms

**Electrical specifications - OUTPUT :****Relay outputs:**

Setpoint setting .....	0...99.9% of span
Hysteresis.....	0...99.9% of span
Updating time .....	100 ms
Delay .....	0.0...99.9 s
Max. voltage .....	250 VRMS
Max. current.....	2 A / AC
Max. AC power .....	500 VA
Max. load at 24 VDC.....	1 A

**Marine approval:**

Det Norske Veritas, Ships & Offshore .....	Standard for Certification No. 2.4
--	------------------------------------

**Observed authority requirements:**

EMC 2004/108/EC .....	Standard: EN 61326-1
LVD 2006/95/EC.....	EN 61010-1
PELV/SELV .....	IEC 364-4-41 and EN 60742
EAC TR-CU 020/2011.....	EN 61326-1

Of span = Of the presently selected range

Order: 2231

Type	Supply
2231	24 VDC : D
	24...230 VAC & : P
	24...250 VDC

## BLOCK DIAGRAM

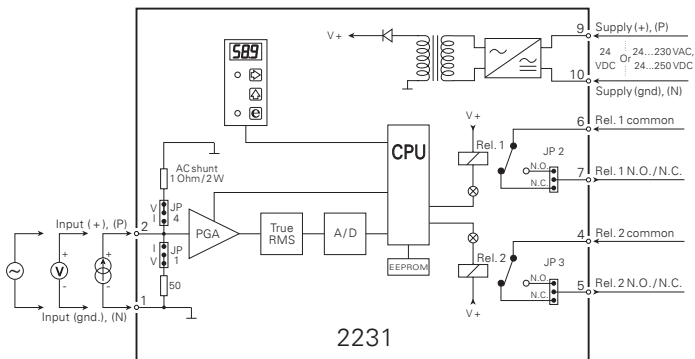

## HARDWARE PROGRAMMING

### Input:

Input	JP1	JP4
0...20 mADC	I	V
0...1 ARMS	I	I
0...250 VDC	V	V
0...250 VRMS	V	V

### Output:

Relay	JP position
Relay 1 normally open	JP 2 N.O.
Relay 1 normally closed	JP 2 N.C.
Relay 2 normally open	JP 3 N.O.
Relay 2 normally closed	JP 3 N.C.

# Routing diagram

If no buttons are pressed for a period of 2 minutes, display returns to stage 0.0

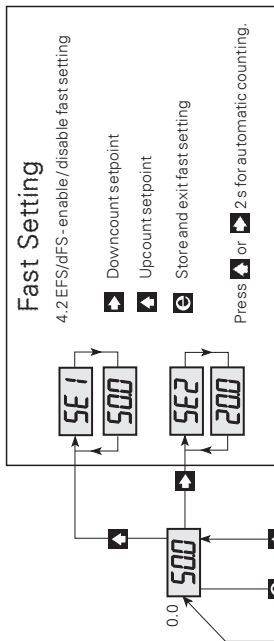

## Programming

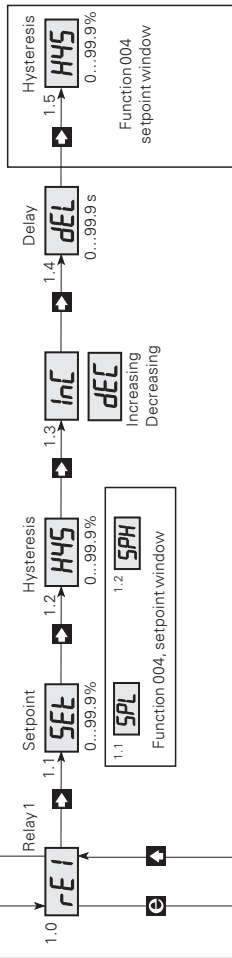
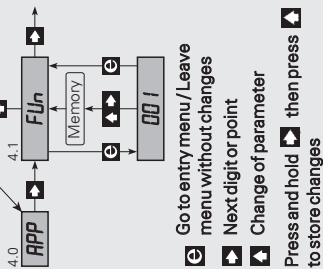

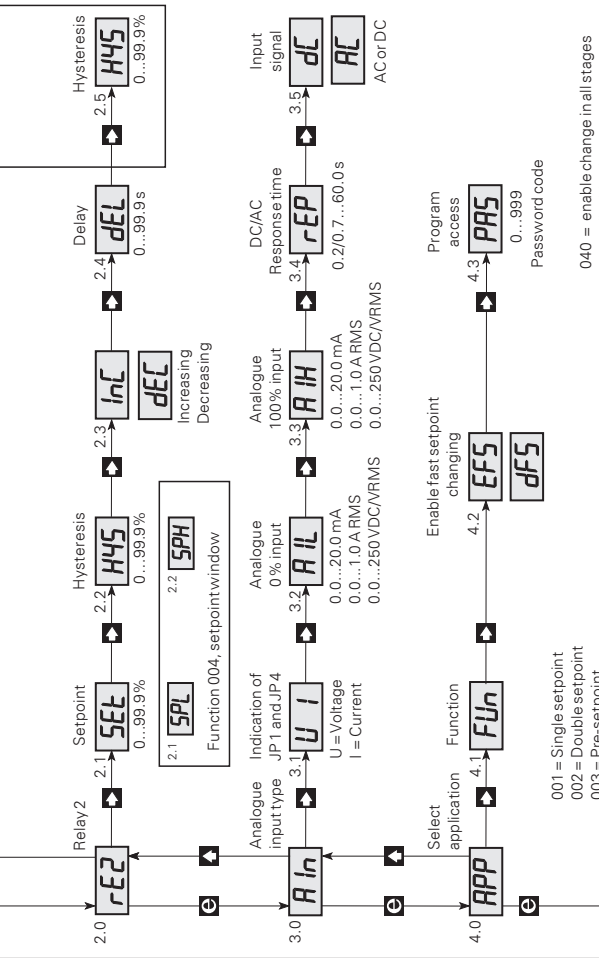

- 001 = Single setpoint
- 002 = Double setpoint
- 003 = Pre-setpoint
- 004 = Setpoint window
- stage 1.5 and 2.5 active
- menu text 1.1, 1.2, 2.1 and 2.2 are different
- 005 = Hold

040 = enable change in all stages  
 --- = disable change

# PROGRAMMING / OPERATION

## THE FUNCTION KEYS

### DOCUMENTATION FOR ROUTING DIAGRAM

#### General

The programming is menu-controlled. The main menus are numbered in level 0 (x.0), and the submenus are numbered in level 1 (x.1 to x.5). Each submenu has an accompanying entry menu. The menus are structured in such a way that the menus most frequently used are closer to the default menu 0.0. Please note that programming is only possible when submenu 4.3 PAS has the value 040.

Main, sub-, and entry menus are selected by the 3 function keys **e**, **▶**, and **▲** as outlined in the routing diagram.

Activating **e** in the submenus will display the present parameter value in the entry menu.

In entry menu, the digit that can be changed will flash. Active digit position is shifted by the **▶** key and changed by the **▲** key. When the decimal point flashes, the position can be changed by the **▶** key.

In entry menu with fixed parameters, you switch between the parameters by the **▶** key.

Store by first activating the **▶** key and the **▲** key simultaneously.

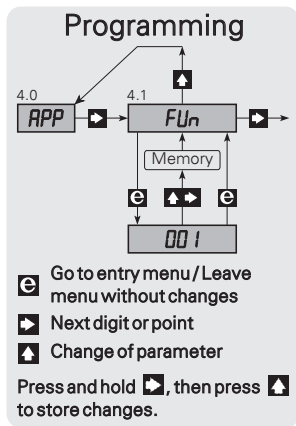

Activate **e** to return to previous menu without changing the parameters.



#### 0.0 DEFAULT - THE INPUT SIGNAL IS DISPLAYED IN %

At power ON, or if no keys have been activated for a period of 2 minutes, the display returns to default.



When menu 4.2 has been selected, EFS - Enable Fast SETTING, fast setpoint change is possible by activating the Fast Setting function. In this menu, the function keys have a special feature as  increases the setpoint and  decreases the setpoint from the value it had when activated. Activating for more than 2 s automatically activates the increment / decrement function. The setpoint value is displayed in % of the input signal.  stores the displayed setpoint value.

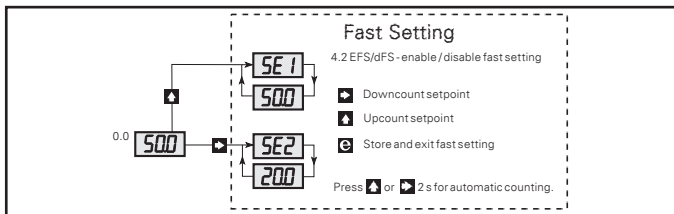

## Begin by selecting the function for the device in menu 4.1

### 1.0 rE1 - SETTING OF PARAMETERS FOR RELAY 1

#### 1.1 SEt / SPL - Setting of relay 1 setpoint

Possible selections are 0...99.9%.

The setpoint is set in % of the input signal. When the selected function in menu 4.1 = {004 = Setpoint window}, the low window value SPL is set in this menu. When the selected function in menu 4.1 = {005 = Hold}, the value resetting the hold function of relay 2 is set.

#### 1.2 HYS / SPH - Setting of relay 1 hysteresis

Possible selections are 0...99.9%.

The hysteresis is set in % of the input signal. The hysteresis is the difference between the setpoint and reset values. When the selected function in menu 4.1 = {004 = Setpoint window}, the upper window value SPH is set in this menu.

### **1.3 InC / dEC - Setting of active relay 1 for increasing / decreasing input signal**

Possible selections are InC or dEC.

If InC is selected, relay 1 will be activated when the input value is higher than the setpoint and deactivated again, when the input value is lower than the setpoint minus the hysteresis. If dEC is selected, relay 1 will be activated when the input value is lower than the setpoint and be deactivated again when the input value is higher than the setpoint plus the hysteresis.

When the selected function in menu 4.1 = {004 = Setpoint window}, InC will result in the activation of the relay, and dEC will result in the deactivation of the relay inside the window.

### **1.4 dEL - Setting of relay 1 time delay**

Possible selections are 0...99.9 s.

The time delay is the period in which the input value must be present before the relay switches state.

### **1.5 HyS - Setting of hysteresis for setpoint window**

Possible selections are 0...99.9%.

When the selected function in menu 4.1 = {004 = Setpoint window}, menu 1.5 is active. The hysteresis is set in % of the input signal and is placed outside the window.

A hysteresis less than 1% is typically an acceptable value.

## **2.0 rE2 - SETTING OF PARAMETERS FOR RELAY 2**

When the selected function in menu 4.1 = {001 = Single setpoint}, all sub-menus (2.1 to 2.5) have no function.

### **2.1 SEt / SPL - Setting of relay 2 setpoint**

Possible selections are 0...99.9%.

The setpoint is set in % of the input signal.

When the selected function in menu 4.1 = {003 = Pre-setpoint}, the percentage pre-setpoint value in relation to the relay 2 setpoint is set.

Menus 2.3 to 2.5 have no function. When the selected function in menu 4.1 = {004 = Setpoint window}, the low window value SPL is set in this menu.

When the selected function in menu 4.1 = {005 = Hold}, the value that activates the hold function on relay 2 is set.

## 2.2 HYS / SPH - Setting of relay 2 hysteresis

Possible selections are 0...99.9%.

The hysteresis is set in % of the input signal. The hysteresis is the difference between the setpoint and reset values. When the selected function in menu 4.1 = {004 = Setpoint window}, the upper window value SPH is set in this menu. When the selected function in menu 4.1 = {005 = Hold}, menu 2.2 has no function.

## 2.3 InC / dEC - Setting of active relay 2 for increasing / decreasing input signal

Possible selections are InC or dEC.

If InC is selected, relay 2 will be activated when the input value is higher than the setpoint and deactivated again when the input value is lower than the setpoint minus the hysteresis. If dEC is selected, relay 2 will be activated when the input value is lower than the setpoint and deactivated when the input value is higher than the setpoint plus the hysteresis.

When the selected function in menu 4.1 = {004 = Setpoint window}, InC will result in the activation of the relay, and dEC will result in the deactivation of the relay inside the window. When the selected function in menu 4.1 = {003 = Pre-setpoint or 004 = Hold}, menu 2.3 has no function.

## 2.4 dEL - Setting of relay 2 time delay

Possible selections are 0...99.9 s.

The time delay is the period in which the input value must be present before the relay switches state.

## 2.5 HyS - Setting of hysteresis for setpoint window

Possible selections are 0...99.9%.

When the selected function in menu 4.1 = {004 = Setpoint window}, menu 2.5 is active. The hysteresis is set in % of the input signal and is placed outside the window.

A hysteresis less than 1% is typically an acceptable value.

## 3.0 AI<sub>n</sub> - SETTING OF SIGNAL INPUT

### 3.1 U / I - Display of input type

There are two alternative displays when setting JP1 on the PCB, U and I.

The input type is detected by JP1. When JP1 is installed in "I", "I" will be displayed, and the input signal range is set in current. When JP1 is installed in "V", "U" will be displayed, and the input signal range is set in voltage. Please note that both JP1 and JP4 must be installed in "I" in connection with the AC current input.

### 3.2 AI<sub>L</sub> - Setting of 0% input signal

Valid selections are DC current 0.0...20.0 mA, AC current 0.0...1.0 ARMS, or DC/AC voltage 0.0...250 VDC/VRMS.

See the hardware programming for correct jumper setting.

### 3.3 AI<sub>H</sub> - Setting of 100% input signal

Valid selections are DC current 0.0...20.0 mA, AC current 0.0...1.0 ARMS, or DC/AC voltage 0.0...250 VDC/VRMS.

See the hardware programming for correct jumper setting.

### 3.4 rEP - Setting of response time

Valid selections are 0.2...60.0 s.

The response time averages the input values acc. to an exponential function. If the set response time is less than the min. response time for the input type, then the min. response time is used.

### 3.5 dC - Setting of DC or AC signal input

Possible selections are DC or AC.

## 4.0 APP - SELECTION OF APPLICATION

### 4.1 FUn - Selection of function

Possible selections are:

#### 001 = Single setpoint:

Single trip amplifier set in main menu 1.0 with setpoint within the range 0...99.9% of the input signal. The hysteresis is set in the range 0...99.9% of the input signal. The parameter selection

determines whether the trip amplifier should be active for increasing (InC) or decreasing (dEC) input signal. The delay time is set in the range 0...99.9 s. Settings in main menu 2.0 rE2 are of no importance as relay 2 is disconnected.

#### 002 = Dual setpoint:

Dual trip amplifier with setpoint on both relays within the range 0...99.9% of the input signal. The hysteresis is set in the range 0...99.9% of the input signal. The parameter selection determines whether the trip amplifiers should be active for increasing (InC) or decreasing (dEC) input signal. The time delay is set in the range 0...99.9 s. Relay 1 is set in main menu 1.0 rE1; relay 2 is set in main menu 2.0 rE2.

#### 003 = Pre-setpoint:

Dual trip amplifier with setpoint on relay 1 within the range 0...99.9% of the input signal and a percentage pre-setpoint on relay 2. On relay 1, the hysteresis is set in the range 0...99.9% of the input signal.

The parameter selection in menu 1.3 InC increasing / dEC decreasing input signal is disconnected, as the pre-setpoint function acts on an increasing (InC) input signal. The time delay is set in the range 0...99.9 s. The relay 2 pre-setpoint is entered in submenu 2.1 as the percentage value by which relay 2 is activated before relay 1, and in submenu 2.2 the percentage hysteresis of the pre-setpoint is entered. In submenus 2.1 and 2.2, settings of 5 and 0.5 respectively will mean that relay 2 is activated 5% earlier than relay 1 and that there will be a hysteresis of 0.5%. In main menu 2.0, the submenus 2.3 and 2.5 are disconnected.

#### 004 = Setpoint window:

Dual trip amplifier with setpoint window on both relays acc. to your choice. The setpoint window is set with a low and an upper value on the input signal thus making the relays active / inactive within the range.

In submenus 1.1 / 2.1 the low percentage value of the input signal is set, and in submenus 1.2 / 2.2 the high percentage value of the input signal is set.

In submenus 1.3 / 2.3 InC increasing / dEC decreasing, the relay function is determined within the setpoint window. If InC is selected, the relays are active; if dEC is selected, the relays are inactive. The time delay is set in the range 0...99.9 s. In submenus 1.5 / 2.5, the hysteresis setting, which is placed outside the setpoint window, is set in % of the input signal.

005 = Hold function on relay 2:

Dual trip amplifier with hold on relay 2. When the input signal increases to the relay 2 setpoint, hold on relay 2 is activated. When the input signal decreases to the relay 1 setpoint, relay 2 is deactivated, this is why the relay 2 setpoint must be higher than the relay 1 setpoint.

The hold point is set in submenu 2.1; the reset point is set in submenu 1.1. In submenu 2.4, the time delay is set in the range 0...99.9 s.

In main menu 2.0, the submenus 2.2 and 2.3 are disconnected.

In main menu 1.0, the submenus 1.2 to 1.4 are still active, as relay 1, apart from determining the reset point on relay 2, can be used as a common trip amplifier.

#### **4.2 EFS - Setting of access to fast setpoint change**

Possible selections are EFS or dFS.

The parameters Enable Fast Setting (EFS) and Disable Fast Setting (dFS) determine the access to fast setpoint change.

#### **4.3 PAS - Programming access code**

Possible selections are 0...999.

When the password is 040, all menu items can be changed. When the password is <> 040, programming of all menu items is blocked, but reading of settings is possible.



**Displays** Programmable displays with a wide selection of inputs and outputs for display of temperature, volume and weight, etc. Feature linearization, scaling, and difference measurement functions for programming via PReset software.



**Ex interfaces** Interfaces for analog and digital signals as well as HART signals between sensors / I/P converters / frequency signals and control systems in Ex zone 0, 1 & 2 and for some devices in zone 20, 21 & 22.



**Isolation** Galvanic isolators for analog and digital signals as well as HART signals. A wide product range with both loop-powered and universal isolators featuring linearization, inversion, and scaling of output signals.





























**Temperature** A wide selection of transmitters for DIN form B mounting and DIN rail devices with analog and digital bus communication ranging from application-specific to universal transmitters.



**Universal** PC or front programmable devices with universal options for input, output and supply. This range offers a number of advanced features such as process calibration, linearization and auto-diagnosis.



- 

[www.preelectronics.fr](http://www.preelectronics.fr)  

[sales-fr@preelectronics.com](mailto:sales-fr@preelectronics.com)
- 

[www.preelectronics.de](http://www.preelectronics.de)  

[sales-de@preelectronics.com](mailto:sales-de@preelectronics.com)
- 

[www.preelectronics.es](http://www.preelectronics.es)  

[sales-es@preelectronics.com](mailto:sales-es@preelectronics.com)
- 

[www.preelectronics.it](http://www.preelectronics.it)  

[sales-it@preelectronics.com](mailto:sales-it@preelectronics.com)
- 

[www.preelectronics.se](http://www.preelectronics.se)  

[sales-se@preelectronics.com](mailto:sales-se@preelectronics.com)
- 

[www.preelectronics.com](http://www.preelectronics.com)  

[sales-uk@preelectronics.com](mailto:sales-uk@preelectronics.com)
- 

[www.preelectronics.com](http://www.preelectronics.com)  

[sales-us@preelectronics.com](mailto:sales-us@preelectronics.com)
- 

[www.preelectronics.cn](http://www.preelectronics.cn)  

[sales-cn@preelectronics.com](mailto:sales-cn@preelectronics.com)
- 

[www.preelectronics.be](http://www.preelectronics.be)  

[sales-be@preelectronics.com](mailto:sales-be@preelectronics.com)

## Head office

Denmark  
 PR electronics A/S  
 Lerbakken 10  
 DK-8410 Rønde

[www.preelectronics.com](http://www.preelectronics.com)  
[sales-dk@preelectronics.com](mailto:sales-dk@preelectronics.com)  
 tel. +45 86 37 26 77  
 fax +45 86 37 30 85



QUALITY SYSTEM AND ENVIRONMENTAL MANAGEMENT SYSTEM  
 DS/EN ISO 9001  
 DS/EN ISO 14001

