

PERFORMANCE
MADE
SMARTER

Product manual

3105

Isolated converter

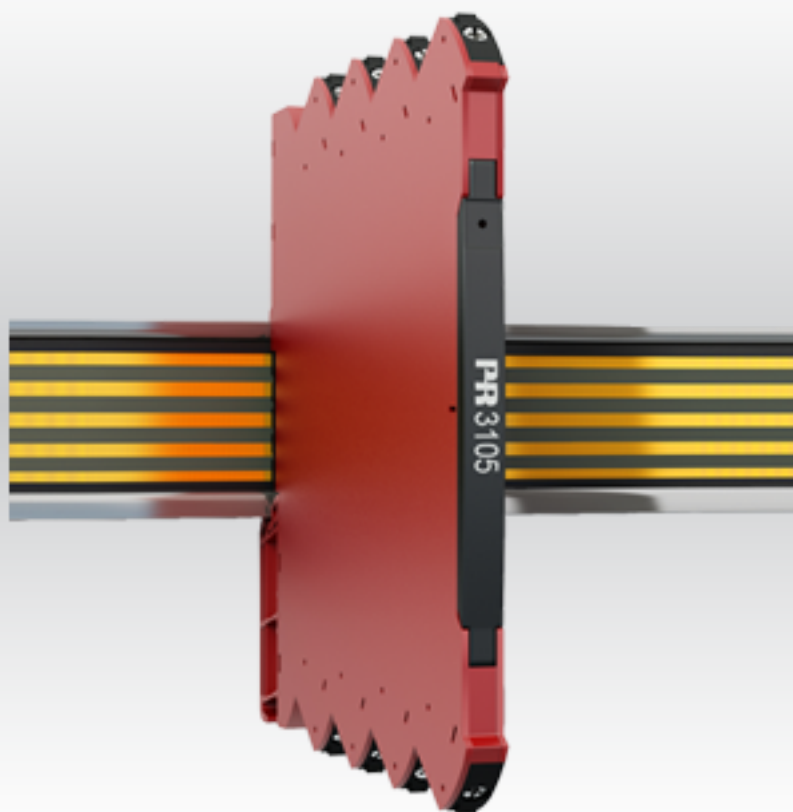

TEMPERATURE | I.S. INTERFACES | COMMUNICATION INTERFACES | MULTIFUNCTIONAL | ISOLATION | DISPLAY

No. 3105V111-EN
From serial no.: 211449001

PR
electronics

6 Product Pillars

to meet your every need

Individually outstanding, unrivalled in combination

With our innovative, patented technologies, we make signal conditioning smarter and simpler. Our portfolio is composed of six product areas, where we offer a wide range of analog and digital devices covering over a thousand applications in industrial and factory automation. All our products comply with or surpass the highest industry standards, ensuring reliability in even the harshest of environments and have a 5-year warranty for greater peace of mind.



Temperature

Our range of temperature transmitters and sensors provides the highest level of signal integrity from the measurement point to your control system. You can convert industrial process temperature signals to analog, bus or digital communications using a highly reliable point-to-point solution with a fast response time, automatic self-calibration, sensor error detection, low drift, and top EMC performance in any environment.



I.S. Interface

We deliver the safest signals by validating our products against the toughest safety standards. Through our commitment to innovation, we have made pioneering achievements in developing I.S. interfaces with SIL 2 Full Assessment that are both efficient and cost-effective. Our comprehensive range of analog and digital intrinsically safe isolation barriers offers multifunctional inputs and outputs, making PR an easy-to-implement site standard. Our backplanes further simplify large installations and provide seamless integration to standard DCS systems.



Communication

We provide inexpensive, easy-to-use, future-ready communication interfaces that can access your PR installed base of products. All the interfaces are detachable, have a built-in display for readout of process values and diagnostics, and can be configured via push-buttons. Product specific functionality includes communication via Modbus and Bluetooth and remote access using our Portable Plant Supervisor (PPS) application, available for iOS, Android.



Multifunction

Our unique range of single devices covering multiple applications is easily deployable as your site standard. Having one variant that applies to a broad range of applications can reduce your installation time and training, and greatly simplify spare parts management at your facilities. Our devices are designed for long-term signal accuracy, low power consumption, immunity to electrical noise and simple programming.



Isolation

Our compact, fast, high-quality 6 mm isolators are based on microprocessor technology to provide exceptional performance and EMC-immunity for dedicated applications at a very low total cost of ownership. They can be stacked both vertically and horizontally with no air gap separation between units required.



Display

Our display range is characterized by its flexibility and stability. The devices meet nearly every demand for display readout of process signals and have universal input and power supply capabilities. They provide a real-time measurement of your process value no matter the industry and are engineered to provide a user-friendly and reliable relay of information, even in demanding environments.

Table of contents

Warnings	4
Symbol identification	5
Safety instructions	6
Installation	7
Mounting / demounting of system 3000	7
Installation on DIN rail / power rail	8
Marking	8
Flexible supply	9
Product features	10
Functional highlights	10
Technical highlights	10
Programming	10
Mounting / installation	10
Connections	11
Specifications	12
Ordering information	12
Technical specifications	12
Common electrical specifications	12
Input and output specifications	13
Approvals & certificates	14
Programming	15
DIP switch configuration	15
Operation & troubleshooting	16
Installation instructions	17
Document history	18

Warnings



WARNING

This device is designed for connection to hazardous electric voltages. Ignoring this warning can result in severe personal injury or mechanical damage.

To avoid the risk of electric shock and fire, the safety instructions in this product manual must be observed and the guidelines followed. The specifications must not be exceeded, and the device must only be applied as described in the following.

Prior to the commissioning of the device, this product manual must be examined carefully.

Only qualified personnel (technicians) should install this device. If the equipment is used in a manner not specified by the manufacturer, the protection provided by the equipment may be impaired.



HAZARDOUS VOLTAGE

Until the device is fixed, do not connect hazardous voltages to the device.

In applications where hazardous voltage is connected to in-/outputs of the device, sufficient spacing or isolation from wires, terminals, and enclosure to surroundings (incl. neighboring devices), must be ensured to maintain protection against electric shock.

Repair of the device and replacement of circuit breakers must be done by PR electronics A/S only.



CAUTION

Potential electrostatic charging hazard. To avoid the risk of explosion due to electrostatic charging of the enclosure, do not handle the units unless the area is known to be safe, or appropriate safety measures are taken to avoid electrostatic discharge.

Symbol identification



Triangle with an exclamation mark: Warning / demand. Potentially lethal situations. Read the manual before installation and commissioning of the device in order to avoid incidents that could lead to personal injury or mechanical damage.



The **CE mark** proves the compliance of the device with the essential requirements of the EU directives.



The **UKCA mark** proves the compliance of the device with the essential requirements of the UK regulations.



The **double insulation symbol** shows that the device is protected by double or reinforced insulation.

Safety instructions

Definitions

Hazardous voltages have been defined as the ranges: 75 to 1500 Volt DC, and 50 to 1000 Volt AC.

Technicians are qualified persons educated or trained to mount, operate, and troubleshoot the device in accordance with safety regulations.

Operators are personnel familiar with the contents of this manual and capable of safe operation of the device.

Receipt and unpacking

Unpack the device without damaging it and check whether the device type corresponds to the one ordered. The packing should always follow the device until it has been permanently mounted.

Environment

Avoid direct sun light, dust, high temperatures, mechanical vibrations and shock, and rain and heavy moisture. If necessary, heating in excess of the stated limits for ambient temperatures should be avoided by way of ventilation.

The device must be installed in pollution degree 2 or better.

The device is designed to be safe up to an altitude of 2 000 m.

The device is designed for indoor use.

Mounting

Only technicians who are familiar with the technical terms, warnings, and instructions in the manual and who are able to follow these should connect the device. Should there be any doubt as to the correct handling of the device, please contact your local distributor or, alternatively, contact PR electronics A/S at www.prelectronics.com

Mounting and connection of the device should comply with national legislation for mounting of electric materials, e.g. wire cross section, protective fuse, and location.

Descriptions of input / output and supply connections are shown in the block diagram and side label.

The device must be supplied from a Power Supply with electrical protection feature SELV or otherwise confirmed to have double or reinforced insulation. A power switch should be easily accessible and close to the device. The power switch shall be marked as the disconnecting unit for the device.

SYSTEM 3000 must be mounted on a DIN rail according to EN 60715.

Year of manufacture can be taken from the first two digits in the serial number.

Calibration and adjustment

During calibration and adjustment, the measuring and connection of external voltages must be carried out according to the specifications of this manual. The technician must use tools and instruments that are safe to use.

Normal operation

Operators are only allowed to adjust and operate devices that are safely fixed in panels, etc., thus avoiding the danger of personal injury and damage. This means there is no electrical shock hazard, and the device is easily accessible.

Cleaning

When disconnected, the device may be cleaned with a cloth moistened with distilled water.

Liability

To the extent the instructions in this manual are not strictly observed, the customer cannot advance a demand against PR electronics A/S that would otherwise exist according to the concluded sales agreement.

Installation

Mounting / demounting of system 3000

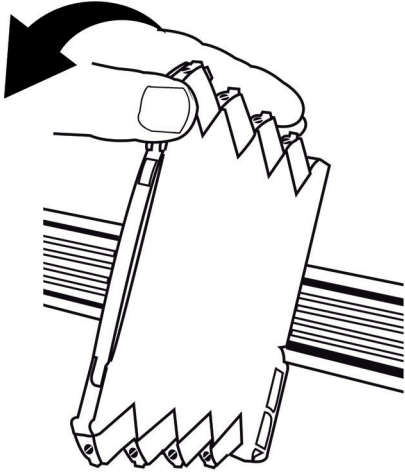
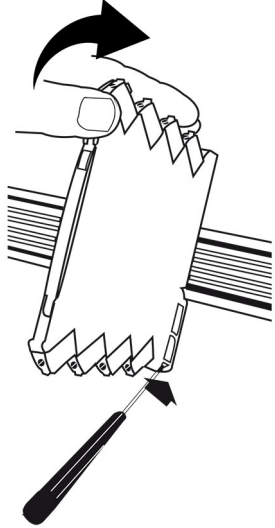
Mounting on DIN rail (Fig. 1)	Demounting from DIN rail (Fig. 2)
Click the device onto the DIN rail.	First, remember to demount the connectors with hazardous voltages. Detach the device from the rail by moving the bottom lock down.
	



WARNING

System 3000 devices can be mounted on DIN rail or power rail (where applicable). When installing system 3000 devices with power rail connectors on a standard 7.5 mm DIN rail the head of the screws holding the rail shall be no more than 3.5 mm high to prevent potential short circuit of the power rail connectors.

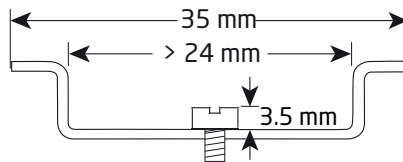

Installation on DIN rail / power rail

The device can be installed on a DIN rail or on a power rail.

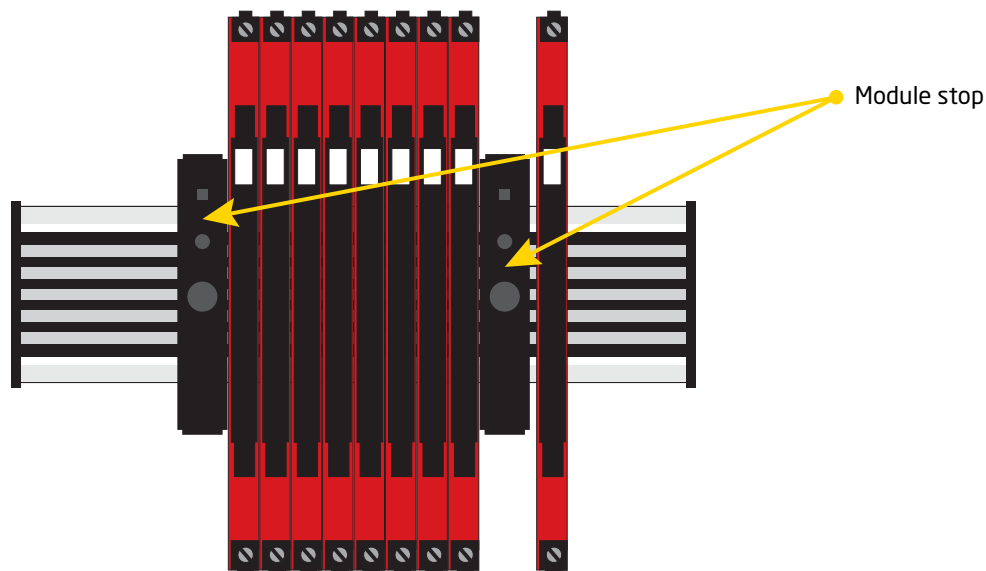

Power supply units can be mounted on the power rail according to customer requirements.



WARNING

For marine applications, the devices must be supported by a module stop (PR part number 9404).

Marking

The front cover of the device has been designed with an area for affixation of a click-on marker. The area assigned to the marker measures 5 x 7.5 mm. Markers from Weidmüller's MultiCard System, type MF 5/7.5, are suitable.

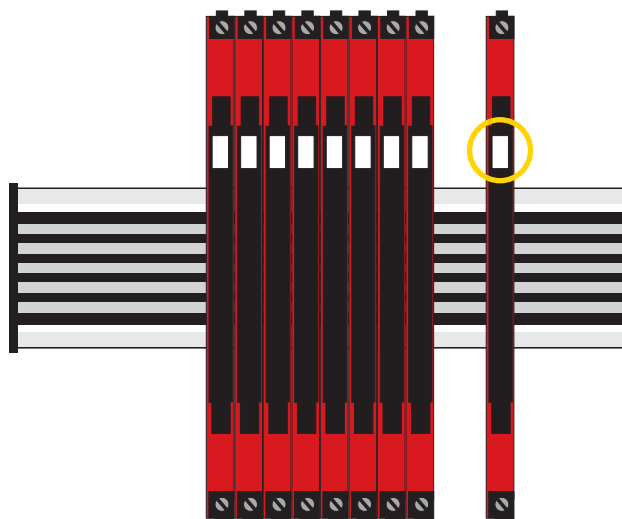

Flexible supply

The technical specifications specify the maximum required power at nominal operating values, e.g. 24 V supply voltage, 60°C ambient temperature, 600 Ω load, and 20 mA output current. External protective fuses may be required depending on power source selected. Protective fuse ratings are specified below.

DIN rail solution - device daisy chain:

The units can be supplied with 24 VDC ±30% via direct wiring and a loop between the devices.

Protective fuse: 2.5 A

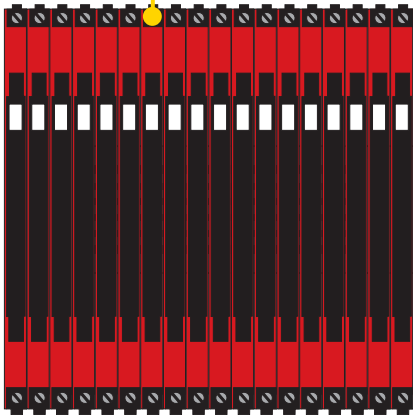

Protective fuse: 0.4 A

Power rail solution #1

Alternately, you can connect 24 VDC to any 3000 device with power rail connector which will then energize other units on the rail.

Power rail solution #2:

The PR 3405 power connector unit allows easy connection of a 24 VDC / 2.5 A source to the power rail.

Protective fuse: 2.5 A

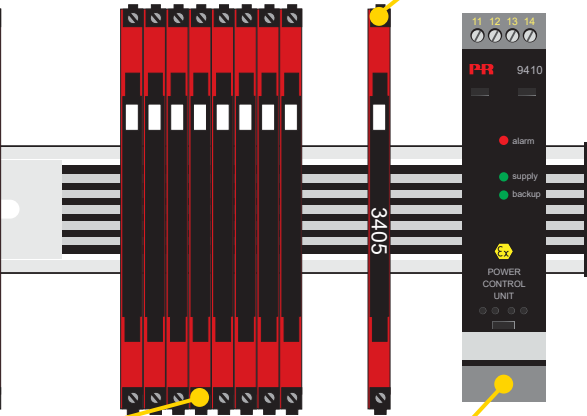

Protective fuse: Located inside the PR 9410

Power rail solution #3:

The PR 9410 power control unit can energize and power 96 W to the rail. Redundant power supplies are possible.

Note

Device types 3xxx-N do not have power rail connectors and can only be supplied with direct wiring on each device.

External fuse characteristics

The 2.5 A fuse must break after not more than 120 seconds at 6.4 A.

Product features

- Isolation and conversion of standard DC signals
- Response time < 7 ms
- DIP switch configuration
- Low cost
- Slimline 6.1 mm housing

Functional highlights

- Galvanic separation of analog current and voltage signals.
- A competitive choice in terms of both price and technology for galvanic isolation of all signal types to SCADA systems or PLC equipment.
- High 3-port isolation provides surge suppression that protects the control system from transients and noise and eliminates ground loops.
- All terminals are over-voltage protected, polarity protected and short-circuit protected.
- Approved for marine applications.

Technical highlights

- Flexible 24 VDC ($\pm 30\%$) supply via power rail or connectors.
- Factory-calibrated measurement ranges.
- Fast response time < 7 ms.
- Excellent signal / noise ratio > 60 dB.
- High galvanic isolation of 2.5 kVAC.
- Inputs and outputs are floating and galvanically separated.
- A green front LED indicates normal operation and malfunction.

Programming

- Easy configuration via DIP switches.

Mounting / installation

- The narrow 6.1 mm housing allows up to 163 units per meter.
- Units can be mounted side by side, horizontally and vertically, without air gap on a standard DIN rail, even at 70°C ambient temperature.
- Units can be supplied separately or installed on PR 9400 power rail.

Connections

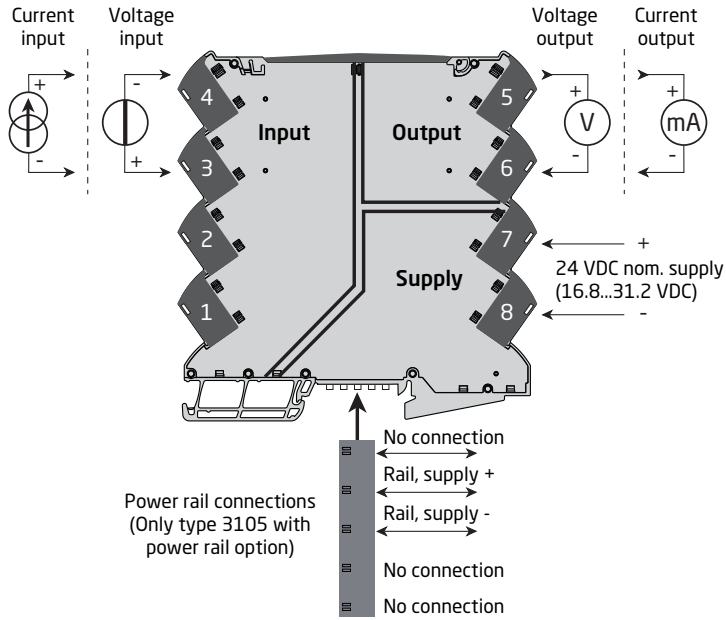

Specifications

Ordering information

Product variants

Type	Version		
3105	Isolated converter	With power rail connector / terminals	: -
		Supplied via terminals	: -N

Example: 3105-N (Isolated converter, supplied via terminals)

Accessories

9404 = Module stop for rail

9421 = Power supply

Accessories for power rail devices

3405 = Power rail connector unit

9400 = Power rail - 7.5 or 15 mm high

9410 = Power control unit

Technical specifications

Environmental conditions

Operating temperature	0...+70°C
Storage temperature	-40...+85°C
Calibration temperature	20...28°C
Relative humidity	< 95% RH non condensing
Protection degree.	IP20
Installation in	Pollution degree 2 & meas. / overvoltage cat. II

Mechanical specifications

Dimensions (HxWxD)	113 x 6.1 x 115 mm
Weight approx.	70 g
DIN rail type	35 x 15 mm DIN rail (EN 60715)
Wire size.	0.13...2.5 mm ² / AWG 26...12 stranded wire
Screw terminal torque	0.5 Nm
Vibration, IEC 60068-2-6.	2...25 Hz = ±1.6 mm, 25...100 Hz = ±4 g

Common electrical specifications

Supply voltage	16.8...31.2 VDC
Max. required power	0.8 W
Max. power dissipation	0.52 W

Max. required power is the maximum power needed at power supply terminals or rail connector.

Max. power dissipation is the maximum power dissipated at nominal operating values.

Isolation voltage, test	2.5 kVAC
Isolation voltage, working	300 VAC (reinforced) / 250 VAC (Zone 2, Div. 2)

Specifications

Double isolation	Input / output / supply
Signal dynamics, input / output	Analog signal chain
Signal / noise ratio	> 60 dB
Response time (0...90%, 100...10%)	< 7 ms
Programming	DIP switches
Cut- off frequency (3 dB)	> 100 Hz

Accuracy values		
Input type	Absolute accuracy	Temperature coefficient
All	$\leq \pm 0.2\%$ of span	$\leq \pm 0.015\%$ of span / °C

EMC immunity influence	< $\pm 0.5\%$ of span
Extended EMC immunity: NAMUR NE 21, A criterion, burst	< $\pm 1\%$ of span

Input and output specifications

Current input

Measurement range.	0...23 mA
Input voltage drop	< 1.5 VDC
Input resistance.	Nom. 20 Ω + PTC 50 Ω
Programmable measurement ranges	0...20 and 4...20 mA

Voltage input

Measurement range.	0...10.25 VDC
Input resistance.	≥ 500 k Ω
Programmable measurement ranges	0...10 / 2...10 / 0...5 / 1...5 VDC

Current output

Signal range (span)	0...23 mA
Load	≤ 600 Ω
Load stability	$\leq 0.002\%$ of span / 100 Ω
Current limit.	≤ 28 mA
Programmable signal ranges	0...20 and 4...20 mA

Voltage output

Signal range.	0...10 VDC
Programmable signal ranges	0...5, 1...5, 0...10, 2...10 V
Load	>10 k Ω

of span = of the selected range

Approvals & certificates

Observed authority requirements

EMC	2014/30/EU & UK SI 2016/1091
LVD	2014/35/EU & UK SI 2016/1101
RoHS.	2011/65/EU & UK SI 2012/3032
EAC	TR-CU 020/2011

Approvals

DNV, Ships & Offshore	TAA00001RW
c UL us, UL 61010-1	E314307

Programming

DIP switch configuration

Applicable devices can be configured via DIP switches. The DIP switches are located on the side of the device and can be adjusted with a small screwdriver or other implement.

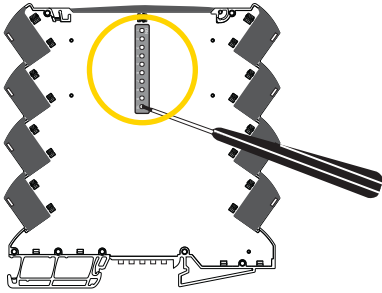

Remember to cycle power for power rail / terminals to reload DIP switch values at power up.

For easy DIP switch programming, our DIP switch configurator can be found at:
www.prelectronics.com/dip-switch-configurator/

Default factory settings

All DIP switches in the OFF position.

Input 0...20 mA
Output 0...20 mA

DIP switch settings

Input Current 0...20 mA		Output Current 0...20 mA	
Input Current 4...20 mA		Output Current 4...20 mA	
Input Voltage 0...10 V		Output Voltage 0...10 V	
Input Voltage 2...10 V		Output Voltage 2...10 V	
Input Voltage 0...5 V		Output Voltage 0...5 V	
Input Voltage 1...5 V		Output Voltage 1...5 V	

Operation & troubleshooting

The 3000 series devices provide multiple features for easy user operation and for performing efficient troubleshooting. Monitoring the operational status is easy from the front LED(s).

Status indicator front LED



Indicator pattern	Condition	Output and loop supply	Action required
OFF	No power supply or internal device failure	De-energized	Connect supply / replace device
ON / OFF	Power-up or restart	De-energized	-
13 Hz, 15 ms	Normal operation	Energized	-
1 Hz, 0.5 s	Restarting due to: Supply error / hardware. RAM or program flow error.	De-energized	Adjust supply / replace device
1 Hz, 15 ms	Incorrect DIP switch setting	De-energized	Correct setting and re-power device

Installation instructions

UL installation

Use 60/75°C copper conductors only.

Wire size. AWG 26-12

UL file number. E314307

The device is an Open Type Listed Process Control Equipment. To prevent injury resulting from accessibility to live parts the equipment must be installed in an enclosure. The Power Supply unit must comply with NEC Class 2, as described by the National Electrical Code® (ANSI / NFPA 70).

Document history

The following list provides notes concerning revisions of this document.

Rev. ID	Date	Notes
108	1745	Models 31xx-N added. Specifications for max. required power and power dissipation added.
109	1939	Side label updated.
110	2108	Side label updated.
111	2205	Side label updated.

We are near you, *all over the world*

Our trusted red boxes are supported wherever you are

All our devices are backed by expert service and a 5-year warranty. With each product you purchase, you receive personal technical support and guidance, day-to-day delivery, repair without charge within the warranty period and easily accessible documentation.

We are headquartered in Denmark, and have offices and authorized partners the world over. We are a local

business with a global reach. This means that we are always nearby and know your local markets well. We are committed to your satisfaction and provide PERFORMANCE MADE SMARTER all around the world.

For more information on our warranty program, or to meet with a sales representative in your region, visit prelectronics.com.

Benefit today from *PERFORMANCE MADE SMARTER*

PR electronics is the leading technology company specialized in making industrial process control safer, more reliable and more efficient. Since 1974, we have been dedicated to perfecting our core competence of innovating high precision technology with low power consumption. This dedication continues to set new standards for products communicating, monitoring and connecting our customers' process measurement points to their process control systems.

Our innovative, patented technologies are derived from our extensive R&D facilities and from having a great understanding of our customers' needs and processes. We are guided by principles of simplicity, focus, courage and excellence, enabling some of the world's greatest companies to achieve PERFORMANCE MADE SMARTER.