

PERFORMANCE  
MADE  
SMARTER

# Product manual

# 3111

# *TC converter - isolated*

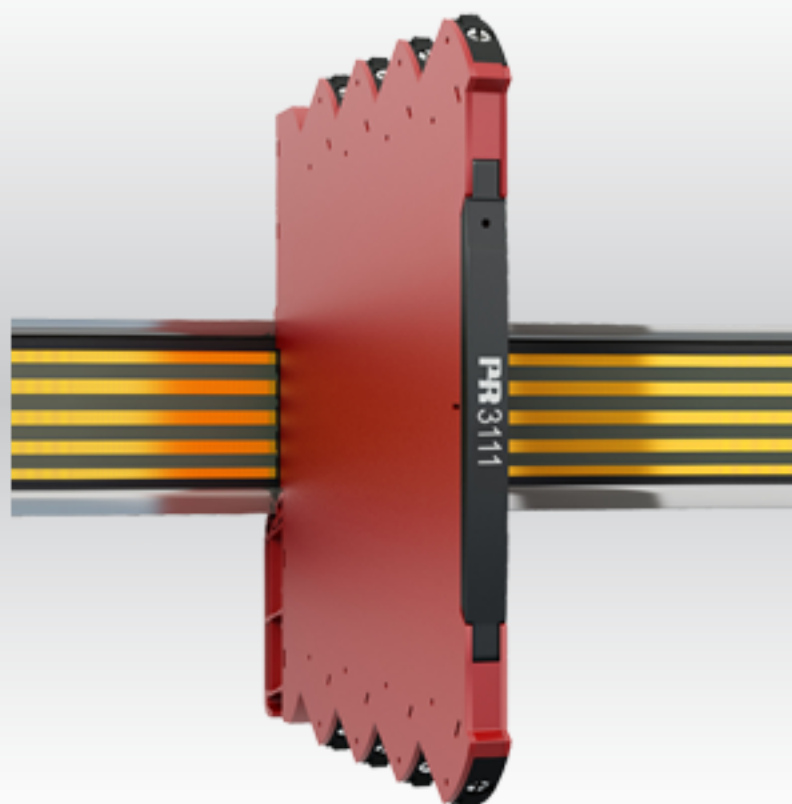

TEMPERATURE | I.S. INTERFACES | COMMUNICATION INTERFACES | MULTIFUNCTIONAL | ISOLATION | DISPLAY

No. 3111V107-EN  
From serial no.: 211449001



# 6 Product Pillars

## *to meet your every need*

Individually outstanding, unrivalled in combination

With our innovative, patented technologies, we make signal conditioning smarter and simpler. Our portfolio is composed of six product areas, where we offer a wide range of analog and digital devices covering over a thousand applications in industrial and factory automation. All our products comply with or surpass the highest industry standards, ensuring reliability in even the harshest of environments and have a 5-year warranty for greater peace of mind.



Temperature

Our range of temperature transmitters and sensors provides the highest level of signal integrity from the measurement point to your control system. You can convert industrial process temperature signals to analog, bus or digital communications using a highly reliable point-to-point solution with a fast response time, automatic self-calibration, sensor error detection, low drift, and top EMC performance in any environment.



I.S. Interface

We deliver the safest signals by validating our products against the toughest safety standards. Through our commitment to innovation, we have made pioneering achievements in developing I.S. interfaces with SIL 2 Full Assessment that are both efficient and cost-effective. Our comprehensive range of analog and digital intrinsically safe isolation barriers offers multifunctional inputs and outputs, making PR an easy-to-implement site standard. Our backplanes further simplify large installations and provide seamless integration to standard DCS systems.



Communication

We provide inexpensive, easy-to-use, future-ready communication interfaces that can access your PR installed base of products. All the interfaces are detachable, have a built-in display for readout of process values and diagnostics, and can be configured via push-buttons. Product specific functionality includes communication via Modbus and Bluetooth and remote access using our Portable Plant Supervisor (PPS) application, available for iOS, Android.



Multifunction

Our unique range of single devices covering multiple applications is easily deployable as your site standard. Having one variant that applies to a broad range of applications can reduce your installation time and training, and greatly simplify spare parts management at your facilities. Our devices are designed for long-term signal accuracy, low power consumption, immunity to electrical noise and simple programming.



Isolation

Our compact, fast, high-quality 6 mm isolators are based on microprocessor technology to provide exceptional performance and EMC-immunity for dedicated applications at a very low total cost of ownership. They can be stacked both vertically and horizontally with no air gap separation between units required.



Display

Our display range is characterized by its flexibility and stability. The devices meet nearly every demand for display readout of process signals and have universal input and power supply capabilities. They provide a real-time measurement of your process value no matter the industry and are engineered to provide a user-friendly and reliable relay of information, even in demanding environments.

# Table of contents

Warnings . . . . .	4
Symbol identification . . . . .	5
Safety instructions . . . . .	6
Installation . . . . .	7
Mounting / demounting of system 3000 . . . . .	7
Installation on DIN rail / power rail . . . . .	8
Marking . . . . .	8
Flexible supply . . . . .	9
Product features . . . . .	10
Functional highlights . . . . .	10
Technical highlights . . . . .	10
Programming . . . . .	10
Mounting / installation . . . . .	10
Connections . . . . .	11
Specifications . . . . .	12
Ordering information . . . . .	12
Technical specifications . . . . .	12
Common electrical specifications . . . . .	12
Input and output specifications . . . . .	13
Approvals & certificates . . . . .	14
Programming . . . . .	15
DIP switch configuration . . . . .	15
Operation & troubleshooting . . . . .	18
Installation instructions . . . . .	19
Document history . . . . .	20

## Warnings



### WARNING

This device is designed for connection to hazardous electric voltages. Ignoring this warning can result in severe personal injury or mechanical damage.

To avoid the risk of electric shock and fire, the safety instructions in this product manual must be observed and the guidelines followed. The specifications must not be exceeded, and the device must only be applied as described in the following.

Prior to the commissioning of the device, this product manual must be examined carefully.

Only qualified personnel (technicians) should install this device. If the equipment is used in a manner not specified by the manufacturer, the protection provided by the equipment may be impaired.



### HAZARDOUS VOLTAGE

Until the device is fixed, do not connect hazardous voltages to the device.

In applications where hazardous voltage is connected to in-/outputs of the device, sufficient spacing or isolation from wires, terminals, and enclosure to surroundings (incl. neighboring devices), must be ensured to maintain protection against electric shock.

**Repair of the device and replacement of circuit breakers must be done by PR electronics A/S only.**



### CAUTION

Potential electrostatic charging hazard. To avoid the risk of explosion due to electrostatic charging of the enclosure, do not handle the units unless the area is known to be safe, or appropriate safety measures are taken to avoid electrostatic discharge.

## Symbol identification



**Triangle with an exclamation mark:** Warning / demand. Potentially lethal situations. Read the manual before installation and commissioning of the device in order to avoid incidents that could lead to personal injury or mechanical damage.



The **CE mark** proves the compliance of the device with the essential requirements of the EU directives.



The **UKCA mark** proves the compliance of the device with the essential requirements of the UK regulations.



The **double insulation symbol** shows that the device is protected by double or reinforced insulation.



**Ex** devices have been approved acc. to the ATEX directive for use in connection with installations in explosive areas. See installation instructions.

# Safety instructions

## Definitions

Hazardous voltages have been defined as the ranges: 75 to 1500 Volt DC, and 50 to 1000 Volt AC.

Technicians are qualified persons educated or trained to mount, operate, and troubleshoot the device in accordance with safety regulations.

Operators are personnel familiar with the contents of this manual and capable of safe operation of the device.

## Receipt and unpacking

Unpack the device without damaging it and check whether the device type corresponds to the one ordered. The packing should always follow the device until it has been permanently mounted.

## Environment

Avoid direct sun light, dust, high temperatures, mechanical vibrations and shock, and rain and heavy moisture. If necessary, heating in excess of the stated limits for ambient temperatures should be avoided by way of ventilation.

The device must be installed in pollution degree 2 or better.

The device is designed to be safe up to an altitude of 2 000 m.

The device is designed for indoor use.

## Mounting

Only technicians who are familiar with the technical terms, warnings, and instructions in the manual and who are able to follow these should connect the device. Should there be any doubt as to the correct handling of the device, please contact your local distributor or, alternatively, contact PR electronics A/S at [www.prelectronics.com](http://www.prelectronics.com)

Mounting and connection of the device should comply with national legislation for mounting of electric materials, e.g. wire cross section, protective fuse, and location.

Descriptions of input / output and supply connections are shown in the block diagram and side label.

The device must be supplied from a Power Supply with electrical protection feature SELV or otherwise confirmed to have double or reinforced insulation. A power switch should be easily accessible and close to the device. The power switch shall be marked as the disconnecting unit for the device.

SYSTEM 3000 must be mounted on a DIN rail according to EN 60715.

Year of manufacture can be taken from the first two digits in the serial number.

## Calibration and adjustment

During calibration and adjustment, the measuring and connection of external voltages must be carried out according to the specifications of this manual. The technician must use tools and instruments that are safe to use.

## Normal operation

Operators are only allowed to adjust and operate devices that are safely fixed in panels, etc., thus avoiding the danger of personal injury and damage. This means there is no electrical shock hazard, and the device is easily accessible.

## Cleaning

When disconnected, the device may be cleaned with a cloth moistened with distilled water.

## Liability

To the extent the instructions in this manual are not strictly observed, the customer cannot advance a demand against PR electronics A/S that would otherwise exist according to the concluded sales agreement.

# Installation

## Mounting / demounting of system 3000

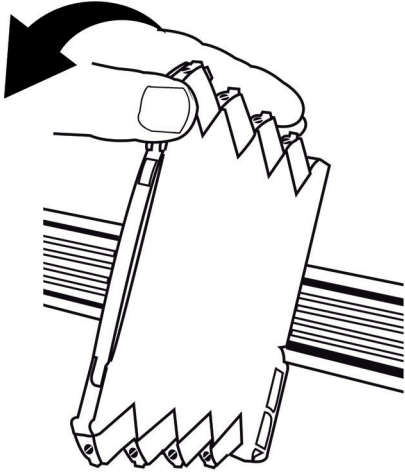
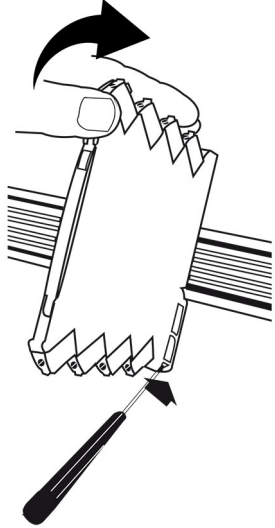
Mounting on DIN rail (Fig. 1)	Demounting from DIN rail (Fig. 2)
Click the device onto the DIN rail.	First, remember to demount the connectors with hazardous voltages. Detach the device from the rail by moving the bottom lock down
	



**WARNING**

System 3000 devices can be mounted on DIN rail or power rail (where applicable). When installing system 3000 devices with power rail connectors on a standard 7.5 mm DIN rail the head of the screws holding the rail shall be no more than 3.5 mm high to prevent potential short circuit of the power rail connectors.

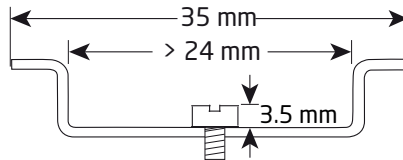

## Installation on DIN rail / power rail

The device can be installed on a DIN rail or on a power rail.

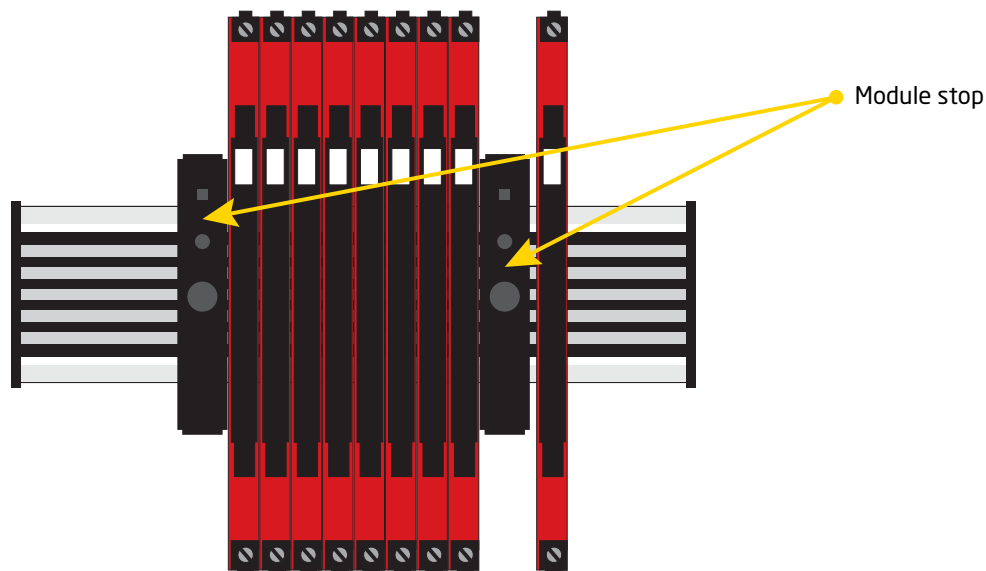

Power supply units can be mounted on the power rail according to customer requirements.



### WARNING

For marine applications, the devices must be supported by a module stop (PR part number 9404).

## Marking

The front cover of the device has been designed with an area for affixation of a click-on marker. The area assigned to the marker measures 5 x 7.5 mm. Markers from Weidmüller's MultiCard System, type MF 5/7.5, are suitable.

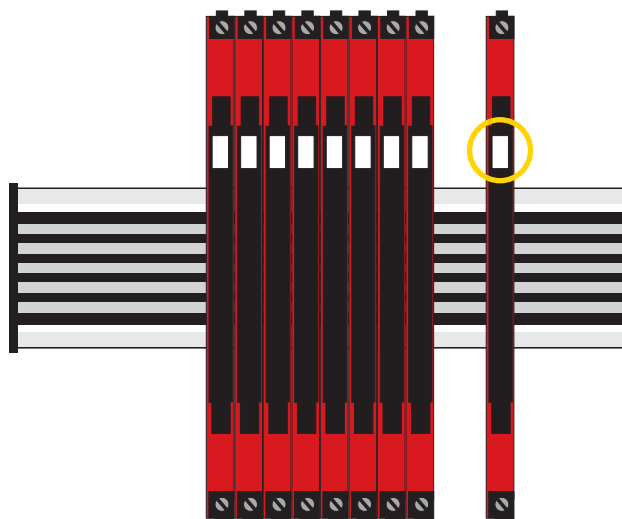

## Flexible supply

The technical specifications specify the maximum required power at nominal operating values, e.g. 24 V supply voltage, 60°C ambient temperature, 600 Ω load, and 20 mA output current. External protective fuses may be required depending on power source selected. Protective fuse ratings are specified below.

### DIN rail solution - device daisy chain:

The units can be supplied with 24 VDC ±30% via direct wiring and a loop between the devices.

Protective fuse: 2.5 A

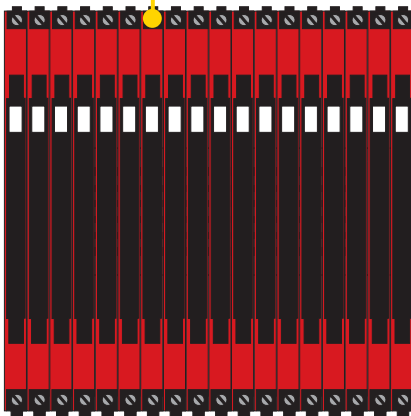

Protective fuse: 0.4 A

### Power rail solution #1

Alternately, you can connect 24 VDC to any 3000 device with power rail connector which will then energize other units on the rail.

### Power rail solution #2:

The PR 3405 power connector unit allows easy connection of a 24 VDC / 2.5 A source to the power rail.

Protective fuse: 2.5 A

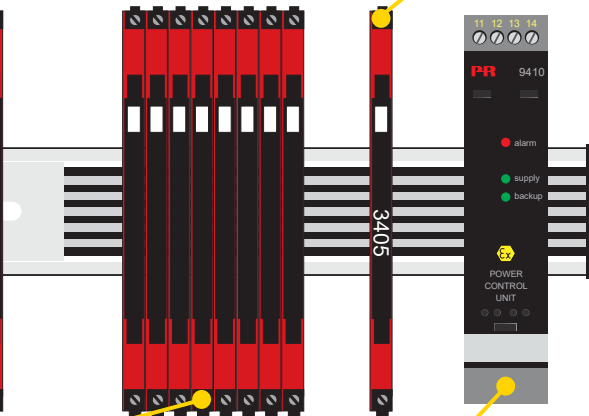

Protective fuse: Located inside the PR 9410

### Power rail solution #3:

The PR 9410 power control unit can energize and power 96 W to the rail. Redundant power supplies are possible.

## Note

Device types 3xxx-N do not have power rail connectors and can only be supplied with direct wiring on each device.

## External fuse characteristics

The 2.5 A fuse must break after not more than 120 seconds at 6.4 A.

## Product features

- Excellent accuracy, better than 0.05% of span
- Excellent EMC performance and 50/60 Hz noise suppression
- Selectable < 30 ms / 300 ms response time
- Pre-calibrated temperature ranges selectable via DIP switches
- Slimline 6.1 mm housing

### Functional highlights

- Temperature converter which measures standard TC J and K temperature sensors, and provides an isolated analog current or voltage output signal.
- High 3-port isolation provides surge suppression that protects the control system from transients and noise and eliminates ground loops.
- All terminals are over-voltage protected, polarity protected and short-circuit protected.
- The device can be mounted in Safe area or in Zone 2 / Division 2 areas and is approved for marine applications.

### Technical highlights

- Flexible 24 VDC ( $\pm 30\%$ ) supply via power rail or connectors.
- Excellent conversion accuracy in all available ranges, better than 0.05% of span.
- Selectable internal / external CJC.
- < 30 ms fast response time with simultaneous sensor error detection when selected.
- Selectable 300 ms response time when signal dampening is needed.
- Meeting the NAMUR NE21 recommendations, this device ensures top measurement performance in harsh EMC environments.
- The device meets the NAMUR NE43 standard defining out of range and sensor error output values.
- Excellent signal / noise ratio > 60 dB.
- High galvanic isolation of 2.5 kVAC.
- A green front LED indicates normal operation, status of the input sensor and malfunction.
- Wide ambient temperature range: -25...+70°C.

### Programming

- Easy configuration via DIP switches.
- Selectable DIP settings for easy configuration of more than 1000 factory calibrated measurement ranges.

### Mounting / installation

- The narrow 6.1 mm housing allows up to 163 units per meter.
- Units can be mounted side by side, horizontally and vertically, without air gap on a standard DIN rail, even at 70°C ambient temperature.
- Units can be supplied separately or installed on PR 9400 power rail.

# Connections

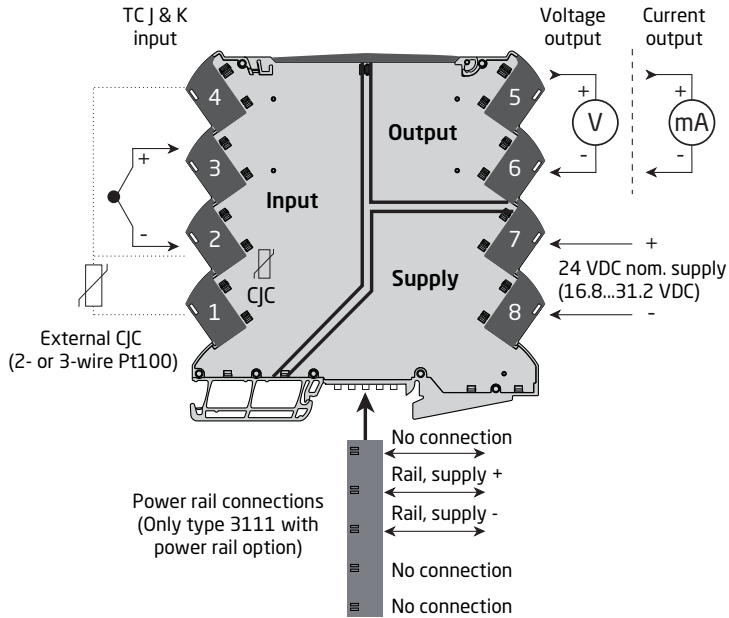

# Specifications

## Ordering information

### Product variants

Type	Version		
3111	TC converter - isolated	With power rail connector / terminals	: -
		Supplied via terminals	: -N

Example: 3111-N (TC converter - isolated, supplied via terminals)

### Accessories

9404 = Module stop for rail

9421 = Power supply

### Accessories for power rail devices

3405 = Power rail connector unit

9400 = Power rail - 7.5 or 15 mm high

9410 = Power control unit

## Technical specifications

### Environmental conditions

Operating temperature . . . . .	-25...+70°C
Storage temperature . . . . .	-40...+85°C
Calibration temperature . . . . .	20...28°C
Relative humidity . . . . .	< 95% RH non condensing
Protection degree. . . . .	IP20
Installation in . . . . .	Pollution degree 2 & meas. / overvoltage cat. II

### Mechanical specifications

Dimensions (HxWxD) . . . . .	113 x 6.1 x 115 mm
Weight approx. . . . .	70 g
DIN rail type . . . . .	35 x 15 mm DIN rail (EN 60715)
Wire size. . . . .	0.13...2.5 mm <sup>2</sup> / AWG 26...12 stranded wire
Screw terminal torque . . . . .	0.5 Nm
Vibration, IEC 60068-2-6. . . . .	2...25 Hz = ±1.6 mm, 25...100 Hz = ±4 g

### Common electrical specifications

Supply voltage . . . . .	16.8...31.2 VDC
Max. required power . . . . .	0.7 W
Max. power dissipation . . . . .	0.7 W

*Max. required power is the maximum power needed at power supply terminals or rail connector.*

*Max. power dissipation is the maximum power dissipated at nominal operating values.*

Isolation voltage, test . . . . .	2.5 kVAC
Isolation voltage, working . . . . .	300 VAC (reinforced) / 250 VAC (Zone 2, Div. 2)

## Specifications

Double isolation . . . . .	Input / output / supply
Signal dynamics, input . . . . .	23 bit
Signal dynamics, output . . . . .	18 bit
Signal / noise ratio . . . . .	> 60 dB
Response time (0...90%, 100...10%) . . . . .	< 30 ms / 300 ms (selectable)
Programming . . . . .	DIP switches
Incorrect DIP-sw setting identification . . . . .	0 V / 0 mA output; LED 0.5 s / 1 Hz

Accuracy - the greater of basic and absolute values:

Accuracy values			
Input type	Basic accuracy	Absolute accuracy	Temperature coefficient
TC	$\leq 0.5^{\circ}\text{C}$	$\leq \pm 0.05\%$ of span	$0.1^{\circ}\text{C} / ^{\circ}\text{C}$ (basic) or $\leq \pm 0.01\%$ of span / $^{\circ}\text{C}$

EMC immunity influence . . . . .	< $\pm 0.5\%$ of span
Extended EMC immunity: NAMUR NE 21, A criterion, burst . . . . .	< $\pm 1\%$ of span

## Input and output specifications

### TC input

Temperature range, TC J . . . . .	-100...+1200 $^{\circ}\text{C}$ - IEC 60584-1
Min. measuring range (span) . . . . .	50 $^{\circ}\text{C}$
Temperature range, TC K . . . . .	-180...+1372 $^{\circ}\text{C}$ - IEC 60584-1
Min. measuring range (span) . . . . .	50 $^{\circ}\text{C}$
Sensor cable resistance. . . . .	< 5 k $\Omega$ per wire
Cold junction compensation (CJC) accuracy:	
Accuracy @ internal CJC. . . . .	Better than $\pm 2.5^{\circ}\text{C}$
Accuracy @ external Pt100. . . . .	Better than $\pm 0.15^{\circ}\text{C}$
Open Thermocouple detection . . . . .	Yes - selectable via DIP switch
Internal CJC error detection. . . . .	Yes
External CJC error detection . . . . .	Yes - selectable via DIP switch

### Common output specifications

Updating time . . . . .	10 ms
-------------------------	-------

### Current output

Signal range (span) . . . . .	0...23 mA
Sensor error indication (0...20 mA) . . . . .	0 mA or 23 mA / OFF
Sensor error indication (4...20 mA) . . . . .	3.5 mA or 23 mA / acc. to NAMUR NE43 or OFF
Load . . . . .	$\leq 600 \Omega$
Load stability . . . . .	$\leq 0.01\%$ of span / 100 $\Omega$
Current limitation @ low output load. . . . .	< 60 mA peak / < 4 mA average
Programmable signal ranges . . . . .	0...20 and 4...20 mA

### Voltage output

Signal range . . . . .	0...10 VDC
Programmable signal ranges . . . . .	0...5, 1...5, 0...10, 2...10 V
Load . . . . .	>10 k $\Omega$
Sensor error indication . . . . .	0 V / 10% above the max. / none

Open output. . . . . < 18 V

Selectable voltage output						
Low range			High range			Min. load
Range	Limit	Sensor error	Range	Limit	Sensor error	
0/1...5 V	0/0.875...5.125 V	0/5.5 V	0/2...10 V	0/1.75...10.25 V	0/11 V	10 kΩ

of span = of the selected range

## Approvals & certificates

### Observed authority requirements

EMC . . . . .	2014/30/EU & UK SI 2016/1091
LVD . . . . .	2014/35/EU & UK SI 2016/1101
RoHS. . . . .	2011/65/EU & UK SI 2012/3032
ATEX. . . . .	2014/34/EU & UK SI 2016/1107
EAC . . . . .	TR-CU 020/2011
EAC Ex. . . . .	TR-CU 012/2011

### Approvals

c UL us, UL 61010-1 . . . . .	E314307
DNV, Ships & Offshore . . . . .	TAA00001RW

### I.S. / Ex approvals

ATEX. . . . .	KEMA 10ATEX0147X
IECEx. . . . .	KEM 10.0068X
UKEX. . . . .	DEKRA 21UKEX0055X
c FM us . . . . .	FM17US0004X / FM17CA0003X
EAC Ex. . . . .	EAEU KZ 7500361.01.01.08756

# Programming

## DIP switch configuration

Applicable devices can be configured via DIP switches. The DIP switches are located on the side of the device and can be adjusted with a small screwdriver or other implement.

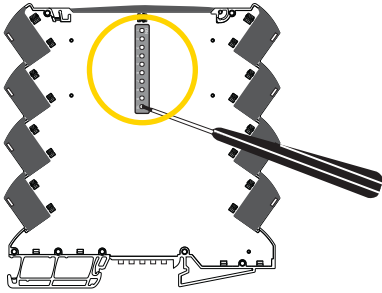

Remember to cycle power for power rail / terminals to reload DIP switch values at power up.

For easy DIP switch programming, our DIP switch configurator can be found at:  
[www.prelectronics.com/dip-switch-configurator/](http://www.prelectronics.com/dip-switch-configurator/)

## Default factory settings

All DIP switches in the OFF position.

Sensor type . . . . .	TC K (int. CJC)
Output range . . . . .	4...20 mA
Error detection . . . . .	Short circuit detection
Error output current. . . . .	3.5 mA
Noise suppression. . . . .	50 Hz
Input lower limit. . . . .	0°C
Input upper limit . . . . .	600°C
Response time . . . . .	< 30 ms
Configuration mode. . . . .	-

DIP switch settings

Sensor	S1	1	2	3
TC J (int. cjc)				●
TC K (int. cjc)	●			●
TC J (ext. cjc)			●	●
TC K (ext. cjc)	●	●	●	

Output	S1	4	5	6
0...20 mA				
4...20 mA	●			
0...10 V				●
2...10 V	●			●
0...5 V			●	●
1...5 V	●	●	●	

● = ON

Sensor Error Detection	S1	7
None		
Enable		●

Output Error Level	S1	8
Downscale		
Upscale		●

Noise Supp.	S1	9	Resp.T.	S1	10
50 Hz			< 30 ms		
60 Hz		●	300 ms		●

Temperature range programming

DIP S2				● = ON	Temperature Range °C																				
Start Temp.	1	2	3	4	End Temp.	5	6	7	8	9	10	End Temp.	5	6	7	8	9	10	End Temp.	5	6	7	8	9	10
-200					0							105		●		●		●	375	●		●		●	
-180				●	5						●	110		●		●	●		400	●		●		●	●
-150			●		10					●		115		●		●	●	●	450	●		●	●		
-100			●	●	15					●	●	120		●	●				500	●		●	●		●
-50		●			20				●			125		●	●			●	550	●		●	●	●	
-25		●		●	25				●		●	130		●	●		●		600	●		●	●	●	●
-10		●	●		30				●	●		135		●	●		●	●	650	●	●				
-5		●	●	●	35				●	●	●	140		●	●	●			700	●	●				●
0	●				40			●				145		●	●	●		●	750	●	●			●	
5	●			●	45			●			●	150		●	●	●	●		800	●	●			●	●
10	●		●		50			●		●		160		●	●	●	●	●	850	●	●		●		
20	●		●	●	55			●		●	●	170	●						900	●	●		●		●
25	●	●			60			●	●			180	●					●	950	●	●		●	●	
50	●	●		●	65			●	●		●	190	●				●		1000	●	●		●	●	●
100	●	●	●		70			●	●	●		200	●				●	●	1050	●	●	●			
200	●	●	●	●	75			●	●	●	●	225	●			●			1100	●	●	●			●
					80			●				250	●			●		●	1150	●	●	●		●	
					85			●			●	275	●			●	●		1200	●	●	●		●	●
					90			●		●		300	●			●	●	●	1250	●	●	●	●		
					95			●		●	●	325	●		●				1300	●	●	●	●		●
					100			●	●			350	●		●			●	1350	●	●	●	●		●
																			1372	●	●	●	●	●	●

Sens. type :	Temp. range °C :
Pt100	-200 - +850°C
TC J	-100 - +1200°C
TC K	-180 - +1372°C

Please note:

- "Start temp" must be lower than "End temp" = correct DIP switch setting
- Only TC input available.  
Valid TC J range: -100...+1200°C = correct DIP switch setting.  
Valid TC K range: -180...+1372°C = correct DIP switch setting.

## Operation & troubleshooting

The 3000 series devices provide multiple features for easy user operation and for performing efficient troubleshooting. Monitoring the operational status is easy from the front LED(s).

### Status indicator front LED



Indicator pattern	Condition	Output and loop supply	Action required
OFF	No power supply or internal device failure	De-energized	Connect supply / replace device
ON / OFF	Power-up or restart	De-energized	-
13 Hz, 15 ms	Normal operation	Energized	-
1 Hz, 500 ms	Incorrect DIP-switch setting	De-energized	Correct setting and re-power device
1 Hz, 15 ms	Sensor error indication	Up- or Downscale	Check sensor

# Installation instructions

## UL installation

Use 60/75°C copper conductors only.

Wire size. . . . .	AWG 26-12
UL file number. . . . .	E314307

The device is an Open Type Listed Process Control Equipment. To prevent injury resulting from accessibility to live parts the equipment must be installed in an enclosure. The Power Supply unit must comply with NEC Class 2, as described by the National Electrical Code® (ANSI / NFPA 70).

## IECEX, ATEX and UKEX installation in Zone 2

IECEX KEM 10.0068 X . . . . .	Ex ec IIC T4 Gc
KEMA 10ATEX0147 X . . . . .	II 3 G Ex ec IIC T4 Gc
DEKRA 21UKEX0055X . . . . .	II 3 G Ex ec IIC T4 Gc

For safe installation, the following must be observed. The device shall only be installed by qualified personnel who are familiar with the national and international laws, directives and standards that apply to this area.

The devices shall be installed in a suitable enclosure providing a degree of protection of at least IP54 according to EN IEC 60079-0, taking into account the environmental conditions under which the equipment will be used.

When the temperature under rated conditions exceeds 70°C at the cable or conduit entry point, or 80°C at the branching point of the conductors, the temperature specification of the selected cable shall be in compliance with the actual measured temperature.

To prevent ignition of the explosive atmospheres, disconnect power before servicing and do not separate connectors when energized and an explosive gas mixture is present.

For installation on power rail in Zone 2, only Power Rail type 9400 supplied by Power Control Unit type 9410 is allowed.

Do not mount or remove devices from the power rail when an explosive gas mixture is present.

## cFMus installation in Division 2 or Zone 2

FM17CA0003X / FM17US0004X . . . . .	Class I, Div. 2, Group A, B, C, D T4 or Class I, Zone 2, AEx nA IIC T4 or Ex nA IIC T4
-------------------------------------	---

In class I, Division 2 or Zone 2 installations, the subject equipment shall be mounted within a tool-secured enclosure which is capable of accepting one or more of Class I, Division 2 wiring methods specified in the National Electrical Code (ANSI/NFPA 70) or in Canada in the Canadian Electrical Code (C22.1).

The 3000 System Isolators and Converters must be connected to limited output NEC Class 2 circuits, as outlined in the National Electrical Code® (ANSI / NFPA 70), only. If the devices are connected to a redundant power supply (two separate power supplies), both must meet this requirement.

Where installed in outdoor or potentially wet locations the enclosure shall at a minimum meet the requirements of IP54.

**Warning:** Substitution of components may impair suitability for zone 2 / division 2.

**Warning:** To prevent ignition of the explosive atmospheres, disconnect power before servicing and do not separate connectors when energised and an explosive gas mixture is present.

**Warning:** Do not mount or remove devices from the power rail when an explosive gas mixture is present.

## Document history

The following list provides notes concerning revisions of this document.

Rev. ID	Date	Notes
103	1803	Models 31xx-N added. Specifications for max. required power and power dissipation added. PESO/CCOE approval added
104	2037	EAC Ex approval added. PESO/CCOE approval discontinued.
105	2108	ATEX and IECEx approvals updated - Ex na changed to Ex ec. Side label updated.
106	2205	UKEX approval added.
107	2450	New EAC Ex certificate.

# We are near you, *all over the world*

## Our trusted red boxes are supported wherever you are

All our devices are backed by expert service and a 5-year warranty. With each product you purchase, you receive personal technical support and guidance, day-to-day delivery, repair without charge within the warranty period and easily accessible documentation.

We are headquartered in Denmark, and have offices and authorized partners the world over. We are a local

business with a global reach. This means that we are always nearby and know your local markets well. We are committed to your satisfaction and provide PERFORMANCE MADE SMARTER all around the world.

For more information on our warranty program, or to meet with a sales representative in your region, visit [prelectronics.com](http://prelectronics.com).

# Benefit today from *PERFORMANCE MADE SMARTER*

PR electronics is the leading technology company specialized in making industrial process control safer, more reliable and more efficient. Since 1974, we have been dedicated to perfecting our core competence of innovating high precision technology with low power consumption. This dedication continues to set new standards for products communicating, monitoring and connecting our customers' process measurement points to their process control systems.

Our innovative, patented technologies are derived from our extensive R&D facilities and from having a great understanding of our customers' needs and processes. We are guided by principles of simplicity, focus, courage and excellence, enabling some of the world's greatest companies to achieve PERFORMANCE MADE SMARTER.