

PERFORMANCE  
MADE  
SMARTER

# Product manual **3000**

## **6 mm series of temperature converters**

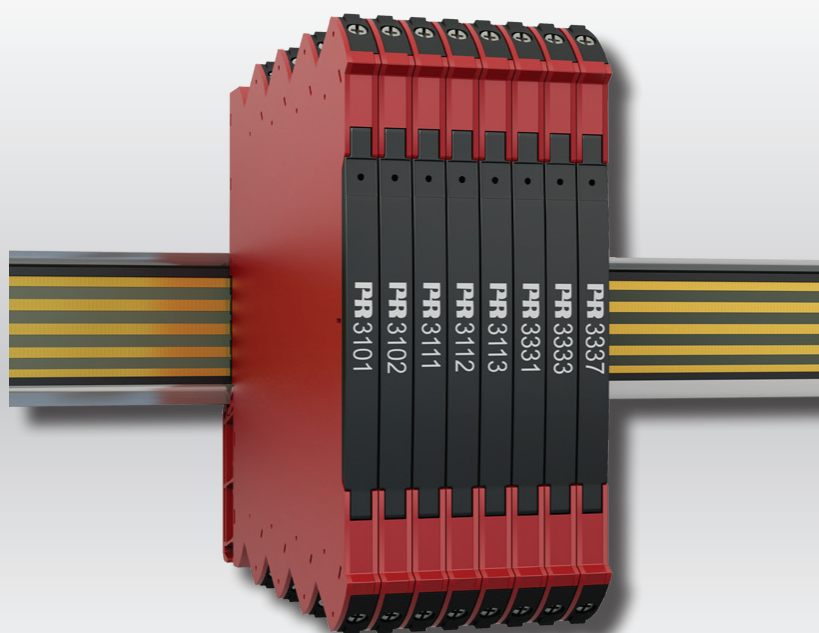

TEMPERATURE | I.S. INTERFACES | COMMUNICATION INTERFACES | MULTIFUNCTIONAL | ISOLATION | DISPLAY

Models no. 3101 / 3102 / 3111 / 3112 / 3113 /  
3331 / 3333 / 3337

No. 3000V106-UK

**PR**  
electronics

# 6 Product Pillars

## *to meet your every need*

### Individually outstanding, unrivalled in combination

With our innovative, patented technologies, we make signal conditioning smarter and simpler. Our portfolio is composed of six product areas, where we offer a wide range of analog and digital devices covering over a thousand applications in industrial and factory automation. All our products comply with or surpass the highest industry standards, ensuring reliability in even the harshest of environments and have a 5-year warranty for greater peace of mind.



Temperature

Our range of temperature transmitters and sensors provides the highest level of signal integrity from the measurement point to your control system. You can convert industrial process temperature signals to analog, bus or digital communications using a highly reliable point-to-point solution with a fast response time, automatic self-calibration, sensor error detection, low drift, and top EMC performance in any environment.



I.S. Interface

We deliver the safest signals by validating our products against the toughest safety standards. Through our commitment to innovation, we have made pioneering achievements in developing I.S. interfaces with SIL 2 Full Assessment that are both efficient and cost-effective. Our comprehensive range of analog and digital intrinsically safe isolation barriers offers multifunctional inputs and outputs, making PR an easy-to-implement site standard. Our backplanes further simplify large installations and provide seamless integration to standard DCS systems.



Communication

We provide inexpensive, easy-to-use, future-ready communication interfaces that can access your PR installed base of products. All the interfaces are detachable, have a built-in display for readout of process values and diagnostics, and can be configured via push-buttons. Product specific functionality includes communication via Modbus and Bluetooth and remote access using our PR Process Supervisor (PPS) application, available for iOS and Android.



Multifunction

Our unique range of single devices covering multiple applications is easily deployable as your site standard. Having one variant that applies to a broad range of applications can reduce your installation time and training, and greatly simplify spare parts management at your facilities. Our devices are designed for long-term signal accuracy, low power consumption, immunity to electrical noise and simple programming.



Isolation

Our compact, fast, high-quality 6 mm isolators are based on microprocessor technology to provide exceptional performance and EMC-immunity for dedicated applications at a very low total cost of ownership. They can be stacked both vertically and horizontally with no air gap separation between units required.



Display

Our display range is characterized by its flexibility and stability. The devices meet nearly every demand for display readout of process signals and have universal input and power supply capabilities. They provide a real-time measurement of your process value no matter the industry and are engineered to provide a user-friendly and reliable relay of information, even in demanding environments.

# 6 mm series of temperature converters 3101 / 3102 / 3111 / 3112 / 3113 / 3331 / 3333 / 3337

## Table of contents

|   |    |
|---|----|
| Warnings .....                                    | 4  |
| Symbol identification .....                       | 4  |
| Safety instructions .....                         | 5  |
| Mounting / demounting of system 3000 .....        | 6  |
| Installation on DIN rail / power rail .....       | 7  |
| Marking .....                                     | 7  |
| Flexible supply .....                             | 8  |
| Applications .....                                | 9  |
| Technical characteristics .....                   | 9  |
| Programming .....                                 | 9  |
| Mounting .....                                    | 9  |
| Connections .....                                 | 10 |
| Product overview .....                            | 11 |
| Order .....                                       | 11 |
| Accessories .....                                 | 11 |
| Technical data .....                              | 12 |
| DIP-switch configuration .....                    | 15 |
| Temperature range programming .....               | 16 |
| Operation & troubleshooting .....                 | 17 |
| Installation instructions .....                   | 18 |
| UL installation .....                             | 18 |
| IECEX, ATEX and UKEX installation in Zone 2 ..... | 18 |
| cFMus installation in Division 2 or Zone 2 .....  | 18 |
| Document history .....                            | 19 |

## Warnings



**GENERAL**

To avoid the risk of electric shock and fire, the safety instructions of this product manual must be observed, and the guidelines followed. The specifications must not be exceeded, and the device must only be applied as described in the following.

Prior to the commissioning of the device, this product manual must be examined carefully.

Only qualified personnel (technicians) should install this device. If the equipment is used in a manner not specified by the manufacturer, the protection provided by the equipment may be impaired.

**To avoid explosion and serious injury: Modules having mechanical failures must be returned to PR electronics for repair or replacement.**

**Repair of the device and replacement of circuit breakers must be done by PR electronics A/S only.**



**HAZARDOUS  
VOLTAGE**

Until the device is fixed, do not connect hazardous voltages to the device.

In applications where hazardous voltage is connected to in-/outputs of the device, sufficient spacing or isolation from wires, terminals, and enclosure - to surroundings (incl. neighboring devices), must be ensured to maintain protection against electric shock.



**CAUTION**

Potential electrostatic charging hazard. To avoid the risk of explosion due to electrostatic charging of the enclosure, do not handle the units unless the area is known to be safe, or appropriate safety measures are taken to avoid electrostatic discharge.

## Symbol identification



**Triangle with an exclamation mark:** Warning /demand. Potentially lethal situations. Read the manual before installation and commissioning of the device in order to avoid incidents that could lead to personal injury or mechanical damage.



**The CE mark** proves the compliance of the device with the essential requirements of the EU directives.



**The UKCA mark** proves the compliance of the device with the essential requirements of the UK regulations.



Ex devices have been approved acc. to the ATEX directive for use in connection with installations in explosive areas. See installation instructions.

# Safety instructions

## Receipt and unpacking

Unpack the device without damaging it and check whether the device type corresponds to the one ordered. The packing should always follow the device until this has been permanently mounted.

## Environment

Avoid direct sun light, dust, high temperatures, mechanical vibrations and shock, and rain and heavy moisture. If necessary, heating in excess of the stated limits for ambient temperatures should be avoided by way of ventilation.

The device must be installed in pollution degree 2 or better.

The device is designed to be safe at least under an altitude up to 2000 m.

The device is designed for indoor use.

## Mounting

Only technicians who are familiar with the technical terms, warnings, and instructions in the manual and who are able to follow these should connect the device. Should there be any doubt as to the correct handling of the device, please contact your local distributor or, alternatively,

**PR electronics A/S**  
**[www.prelectronics.com](http://www.prelectronics.com)**

Mounting and connection of the device should comply with national legislation for mounting of electric materials, e.g. wire cross section, protective fuse, and location.

Descriptions of input / output and supply connections are shown in the block diagram and side label.

The device is provided with field wiring terminals and shall be supplied from a Power Supply having double / reinforced insulation. A power switch should be easily accessible and close to the device. The power switch shall be marked as the disconnecting unit for the device.

SYSTEM 3000 must be mounted on a DIN rail according to EN 60715.

Year of manufacture can be taken from the first two digits in the serial number.

## Cleaning

When disconnected, the device may be cleaned with a cloth moistened with distilled water.

## Liability

To the extent the instructions in this manual are not strictly observed, the customer cannot advance a demand against PR electronics A/S that would otherwise exist according to the concluded sales agreement.

## Mounting / demounting of system 3000

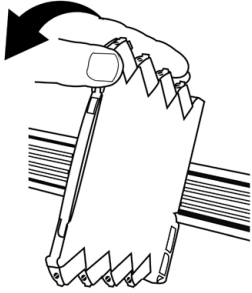
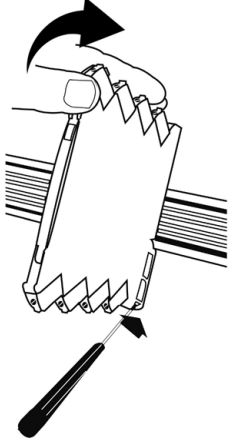
| Mounting on DIN rail / power rail (Fig.1)   | Demounting from DIN rail / power rail (Fig.2)   |
|---|---|
| Click the device onto the rail  | First, remember to demount the connectors with hazardous voltages.<br>Detach the device from the rail by moving the bottom lock down. |
|  |    |



System 3000 devices can be mounted on DIN rail or power rail (where applicable).  
When installing system 3000 devices with power rail connectors on a standard 7.5 mm DIN rail the head of the screws holding the rail shall be no more than 3.5 mm high to prevent potential short circuit of the power rail connectors.

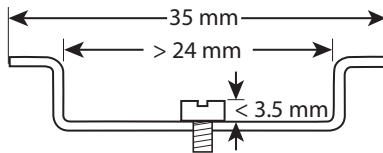

## Installation on DIN rail / power rail

System 3000 devices can be installed on a DIN rail or on a power rail.

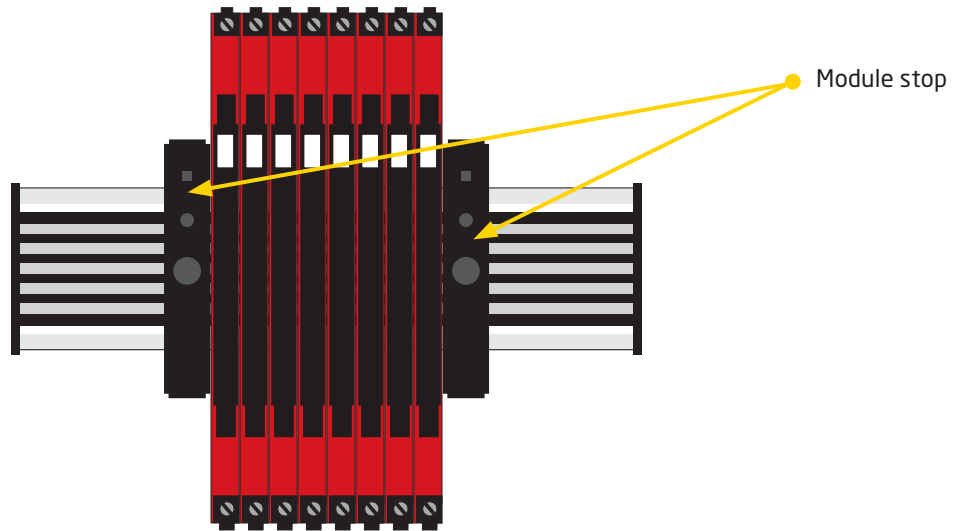

For marine applications, the devices must be supported by a module stop (PR part number 9404).

Power supply units can be mounted on the power rail according to customer requirements.

## Marking

The front cover of the 3000 devices has been designed with an area for affixation of a click-on marker. The area assigned to the marker measures 5 x 7.5 mm. Markers from Weidmüller's MultiCard System, type MF 5/7.5, are suitable.

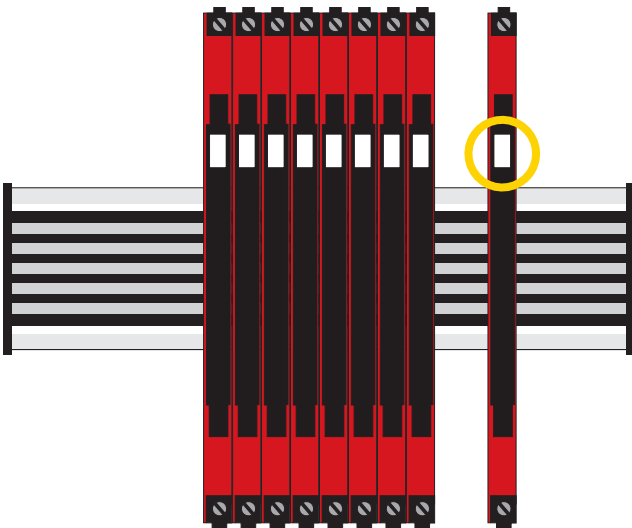

# Flexible supply

The technical specifications specify the maximum required power at nominal operating values, e.g. 24 V supply voltage, 60°C ambient temperature, 600 Ω load, and 20 mA output current.

External protective fuses may be required depending on power source selected. Protective fuse ratings are specified below.

## DIN rail solution - device daisy chain:

The 3101, 3102, 3111, 3112 and 3113 can be supplied with 24 VDC  $\pm$ 30% via direct wiring and a loop between the devices.

Protective fuse: 2.5 A.

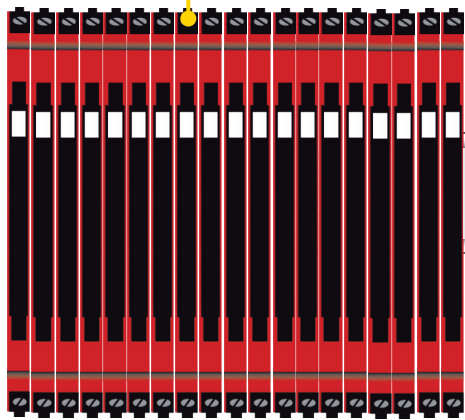

Protective fuse: 0.4 A.

## Power rail solution #1:

Alternately, you can connect 24 VDC to any one 3111, 3112, 3113 device with power rail connector which will then energize other units on the rail.

## Note:

Device type 3101, 3102, 3111-N, 3112-N, 3113-N, 3331, 3333 and 3337 can only be supplied via the DIN rail solution with direct wiring on each device.

## External fuse characteristics:

The 2.5 A fuse must break after not more than 120 seconds at 6.4 A.

## Power rail solution #2:

The PR 3405 power connector unit allows easy connection of a 24 VDC / 2.5 A source to the power rail.

Protective fuse: 2.5 A.

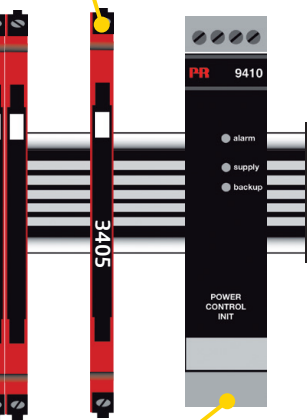

Protective fuse: Located inside the PR 9410.

## Power rail solution #3:

The PR 9410 power control unit can energize and power 96 W to the rail. Redundant power supplies are possible.



## **6 mm series of temperature and converters**

### **3101 / 3102 / 3111 / 3112 / 3113 / 3331 / 3333 / 3337**

- Converts process measurements from Pt100, TC J and K temperature sensors to voltage or current outputs
- Multiple pre-calibrated temperature ranges are selectable via DIP-switches
- High accuracy, better than 0.05% and excellent 50/60 Hz noise suppression
- Fast signal response time < 30 ms
- 3113 and 3337 with HART 7 protocol and fast signal response time < 60 ms
- HART 7 protocol enables extended device programming for 3113 and 3337

#### **Applications**

- The temperature converters measure standard 2-, 3- or 4-wire Pt100 and/or TC J & K temperature sensors, and provides an analog voltage or current output.
- High 3 port isolation provides surge suppression and protects the control system from transients and noise.
- The loop powered devices have high 2-port galvanic separation to eliminate ground loops.
- The devices can be mounted in the Safe area or in Zone 2 / Division 2 areas.
- Approved for marine applications.

#### **Technical characteristics**

- High conversion accuracy, better than 0.05% of span.
- A visible green LED indicates operational status and status of the input sensor.
- All terminals are protected against overvoltage and polarity error.
- Meeting the NAMUR NE21 recommendations, the system 3000 devices ensure top measurement performance in harsh EMC environments.
- The devices meet the NAMUR NE43 standard defining out of range and sensor error output values.
- High galvanic isolation of 2.5 kVAC.
- Excellent signal/noise ratio of > 60 dB.
- Wide temperature operation range of -25...+70°C.

#### **Programming**

- Selectable DIP-mode for easy configuration of more than 1000 factory calibrated measurement ranges with HART read only feature.
- Selectable HART-mode to enable full HART read-write capability

#### **Mounting**

- Units can be mounted side by side, horizontally and vertically, without air gap on a standard DIN rail, even at 70°C ambient temperature.
- Units can be supplied separately (3101 / 3102 / 3331 / 3333 / 3337) or installed on PR 9400 power rail (3111 / 3112 / 3113).
- The narrow 6.1 mm housing allows up to 163 units per meter.

# Connections

## Input wiring

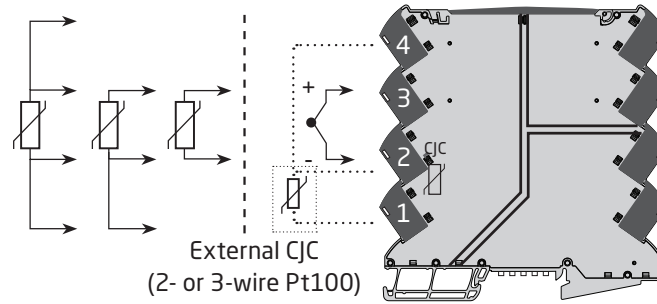

|           |         |       | + | - | CJC | Type |
|-----------|---------|-------|---|---|-----|------|
| -         | -       | -     | 3 | 2 | Y*  | 3101 |
| 1,2 & 3,4 | 1,2 & 3 | 2 & 3 | - | - | N   | 3102 |
| -         | -       | -     | 3 | 2 | Y   | 3111 |
| 1,2 & 3,4 | 1,2 & 3 | 2 & 3 | - | - | N   | 3112 |
| 1,2 & 3,4 | 1,2 & 3 | 2 & 3 | 3 | 2 | Y   | 3113 |
| 1,2 & 3,4 | 1,2 & 3 | 2 & 3 | 3 | 2 | Y   | 3331 |
| 1,2 & 3,4 | 1,2 & 3 | 2 & 3 | - | - | N   | 3333 |
| 1,2 & 3,4 | 1,2 & 3 | 2 & 3 | 3 | 2 | Y   | 3337 |

\*3101 - only internal CJC

## Output wiring

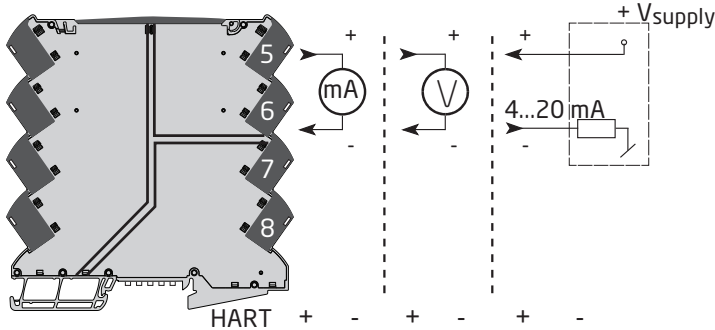

|        |   | HART | + | - | + | - | + | - |
|--------|---|------|---|---|---|---|---|---|
| 3101   | N | 5    | 6 | 5 | 6 | - | - |   |
| 3102   | N | 5    | 6 | 5 | 6 | - | - |   |
| 3111   | N | 5    | 6 | 5 | 6 | - | - |   |
| 3111-N | N | 5    | 6 | 5 | 6 | - | - |   |
| 3112   | N | 5    | 6 | 5 | 6 | - | - |   |
| 3112-N | N | 5    | 6 | 5 | 6 | - | - |   |
| 3113   | Y | 5    | 6 | - | - | - | - |   |
| 3113-N | Y | 5    | 6 | - | - | - | - |   |
| 3331   | N | -    | - | - | - | 5 | 6 |   |
| 3333   | N | -    | - | - | - | 5 | 6 |   |
| 3337   | Y | -    | - | - | - | 5 | 6 |   |
| 3405   | N | -    | - | - | - | - | - |   |

## Supply wiring

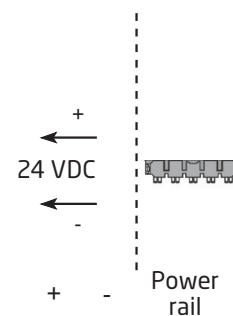

| + | - | Power rail |
|---|---|------------|
| 7 | 8 | N          |
| 7 | 8 | N          |
| 7 | 8 | Y          |
| 7 | 8 | N          |
| 7 | 8 | Y          |
| 7 | 8 | N          |
| 7 | 8 | Y          |
| 7 | 8 | N          |
| - | - | N          |
| - | - | N          |
| - | - | N          |
| 7 | 8 | Y          |

3101, 3102 and 3333: No galvanic isolation  
 3331 and 3337: 2 port isolation (reinforced)  
 3111, 3112 and 3113: 3 port isolation (reinforced)

## Product overview

|        | Input |          |          |                | Output  |         |         | LED | Supply              | Isolated | HART |
|--------|-------|----------|----------|----------------|---------|---------|---------|-----|---------------------|----------|------|
|        | TC    |          |          | Pt100          | Current |         | Voltage |     |                     |          |      |
|        | J & K | Int. CJC | Ext. CJC | 2-, 3-, 4-wire | Active  | Passive |         |     |                     |          |      |
| 3101   | ✓     | ✓        |          |                | ✓       |         | ✓       | ✓   | 24 VDC              |          |      |
| 3102   |       |          |          | ✓              | ✓       |         | ✓       | ✓   | 24 VDC              |          |      |
| 3111   | ✓     | ✓        | ✓        |                | ✓       |         | ✓       | ✓   | 24 VDC / power rail | 2.5 kV   |      |
| 3111-N | ✓     | ✓        | ✓        |                | ✓       |         | ✓       | ✓   | 24 VDC              | 2.5 kV   |      |
| 3112   |       |          |          | ✓              | ✓       |         | ✓       | ✓   | 24 VDC / power rail | 2.5 kV   |      |
| 3112-N |       |          |          | ✓              | ✓       |         | ✓       | ✓   | 24 VDC              | 2.5 kV   |      |
| 3113   | ✓     | ✓        | ✓        | ✓              | ✓       |         |         | ✓   | 24 VDC / power rail | 2.5 kV   | ✓    |
| 3113-N | ✓     | ✓        | ✓        | ✓              | ✓       |         |         | ✓   | 24 VDC              | 2.5 kV   | ✓    |
| 3331   | ✓     | ✓        | ✓        | ✓              |         | ✓       |         |     | Loop-powered        | 2.5 kV   |      |
| 3333   |       |          |          | ✓              |         | ✓       |         |     | Loop-powered        |          |      |
| 3337   | ✓     | ✓        | ✓        | ✓              |         | ✓       |         |     | Loop-powered        | 2.5 kV   | ✓    |

### Order

| Type | Version  |  |
|------|--|--|
| 3101 | TC converter                                   | Supplied via terminals : -   |
| 3102 | Pt100 converter                                | Supplied via terminals : -   |
| 3111 | TC converter - isolated                        | With power rail connector / terminals : -<br>Supplied via terminals : -N |
| 3112 | Pt100 converter - isolated                     | With power rail connector / terminals : -<br>Supplied via terminals : -N |
| 3113 | HART 7 temperature converter - isolated        | With power rail connector / terminals : -<br>Supplied via terminals : -N |
| 3331 | Temperature converter, loop-powered - isolated | Supplied via terminals : -   |
| 3333 | Pt100 converter, loop-powered                  | Supplied via terminals : -   |
| 3337 | HART 7 temperature converter, loop-powered     | Supplied via terminals : -   |

Example: 3112-N (Pt100 converter - isolated, supplied via terminals)

### Accessories

**9404 = Module stop for rail**

#### Accessories for power rail devices

**3405 = Power rail connector unit**

**9400 = Power rail - 7.5 or 15 mm high**

**9410 = Power control unit**

**9421 = Power supply**

## Technical data

### Environmental conditions:

|   |                      |
|---|----------------------|
| Operating temperature . . . . .                               | -25°C to +70°C       |
| Storage temperature . . . . .                                 | -40°C to +85°C       |
| Calibration temperature. . . . .                              | 20...28°C            |
| Relative humidity . . . . .                                   | < 95% RH (non-cond.) |
| Protection degree . . . . .                                   | IP20                 |
| Installation in pollution degree 2 & overvoltage category II. |                      |

### Mechanical specifications:

|                                |  |
|--------------------------------|--|
| Dimensions (HxWxD) . . . . .   | 113 x 6.1 x 115 mm                                     |
| Weight approx. . . . .         | 70 g   |
| DIN rail type. . . . .         | DIN EN 60715 - 35 mm                                   |
| Wire size. . . . .             | 0.13...2.5 mm <sup>2</sup> / AWG 26...12 stranded wire |
| Screw terminal torque. . . . . | 0.5 Nm   |
| Vibration. . . . .             | IEC 60068-2-6  |
| 2...25 Hz. . . . .             | ±1,6 mm  |
| 25...100 Hz. . . . .           | ±4 g   |

### Common electrical specifications:

|                          |                 |
|--------------------------|-----------------|
| Supply voltage . . . . . | 16.8...31.2 VDC |
| Loop-powered:            |                 |
| 3331. . . . .            | 5.5...35 VDC    |
| 3333. . . . .            | 3.3...35 VDC    |
| 3337. . . . .            | 6.2...35 VDC    |

### Power requirements:

| Type | Max. power dissipation | Max. required power |
|------|------------------------|---------------------|
| 3101 | 0.52                   | 0.52                |
| 3102 | 0.52                   | 0.52                |
| 3111 | 0.70                   | 0.70                |
| 3112 | 0.70                   | 0.70                |
| 3113 | 0.70                   | 0.70                |
| 3331 | 0.80                   | 0.80                |
| 3333 | 0.80                   | 0.80                |
| 3337 | 0.80                   | 0.80                |

Max. required power is the maximum power needed at power supply terminals or rail connector.

Max. power dissipation is the maximum power dissipated at nominal operating values.

|  |  |
|--|--|
| Isolation voltage, test . . . . .                      | 2.5 kVAC   |
| Isolation voltage working. . . . .                     | 300 VAC (reinforced) /<br>250 VAC (Zone 2, Div. 2) |
| Double isolation . . . . .                             | Input / output 1 / output 2 / supply               |
| Signal dynamics, input . . . . .                       | 23 bit   |
| Signal dynamics, output . . . . .                      | 18 bit   |
| Signal / noise ratio. . . . .                          | Min. 60 dB   |
| Long-term stability, better than (only 3113) . . . . . | ±0.1% of span / year (±0.3% of span / 5 years)     |

## Response time

|      | Selectable |          | HART read only mode | HART mode   |
|------|------------|----------|---------------------|-------------|
|      | < 30 ms    | < 300 ms | < 60 ms             | 0.06...60 s |
| 3101 | ✓          | ✓        |                     |             |
| 3102 | ✓          | ✓        |                     |             |
| 3111 | ✓          | ✓        |                     |             |
| 3112 | ✓          | ✓        |                     |             |
| 3113 |            |          | ✓                   | ✓           |
| 3331 | ✓          | ✓        |                     |             |
| 3333 | ✓          | ✓        |                     |             |
| 3337 |            |          | ✓                   | ✓           |

## Incorrect DIP-sw setting identification:

Supplied . . . . . 0 V / 0 mA output; LED 0.5 s / 1 Hz  
 Loop-powered . . . . . 3.5 mA output

## Accuracy

| Device                    | Input | Basic accuracy             | General accuracy             | Temperature coefficient  |
|---------------------------|-------|----------------------------|------------------------------|--|
| 3112, 3113,<br>3331, 3337 | Pt100 | $\leq 0.1^{\circ}\text{C}$ | $\leq \pm 0.05\%$<br>of span | $0.02^{\circ}\text{C}/^{\circ}\text{C}$ (basic) or<br>$\leq \pm 0.01\%$ of span / $^{\circ}\text{C}$ |
| 3111, 3113,<br>3331, 3337 | TC    | $\leq 0.5^{\circ}\text{C}$ |                              | $0.1^{\circ}\text{C}/^{\circ}\text{C}$ (basic) or<br>$\leq \pm 0.01\%$ of span / $^{\circ}\text{C}$  |
| 3102, 3333                | Pt100 | $\leq 0.2^{\circ}\text{C}$ | $\leq \pm 0.1\%$ of<br>span  | $0.02^{\circ}\text{C}/^{\circ}\text{C}$ (basic) or<br>$\leq \pm 0.01\%$ of span / $^{\circ}\text{C}$ |
| 3101                      | TC    | $\leq 1^{\circ}\text{C}$   |                              | $0.1^{\circ}\text{C}/^{\circ}\text{C}$ (basic) or<br>$\leq \pm 0.01\%$ of span / $^{\circ}\text{C}$  |

EMC immunity influence . . . . .  $< \pm 0.5\%$  of span

## Extended EMC immunity:

NAMUR NE 21 . . . . .  $< \pm 1\%$  of span

## Input specifications:

### Specifications for Pt100 input:

Temperature range, Pt100 . . . . .  $-200\dots+850^{\circ}\text{C}$  - IEC 60751  
 Min. measuring range (span) . . . . .  $10^{\circ}\text{C}$   
 Sensor current . . . . .  $< 150\ \mu\text{A}$   
 Sensor cable resistance . . . . .  $< 50\ \Omega$  per wire  
 Effect of sensor cable resistance, 3- / 4-wire . . . . .  $< 0.002\ \Omega / \Omega$   
 Sensor error detection . . . . . Yes - selectable via DIP-switch  
 Broken sensor detection . . . . .  $> 800\ \Omega$   
 Shorted sensor detection . . . . .  $< 18\ \Omega$

### Specifications for TC input:

Temperature range, TC J . . . . .  $-100\dots+1200^{\circ}\text{C}$  - IEC 60584-1  
 Min. measuring range (span) . . . . .  $50^{\circ}\text{C}$   
 Temperature range, TC K . . . . .  $-180\dots+1372^{\circ}\text{C}$  - IEC 60584-1  
 Min. measuring range (span) . . . . .  $50^{\circ}\text{C}$   
 Sensor cable resistance . . . . .  $< 5\ \text{k}\Omega$  per wire

### Cold junction compensation (CJC) accuracy:

Accuracy @ external Pt100 . . . . . Better than  $\pm 0.15^{\circ}\text{C}$   
 Accuracy @ internal CJC . . . . . Better than  $\pm 2.5^{\circ}\text{C}$

Open Thermocouple detection. . . . . Yes - selectable via DIP-switch  
 Internal CJC error detection. . . . . Yes  
 External CJC error detection . . . . . Yes - selectable via DIP-switch

**Output specifications:**

|      | Current output |         |            |             |                 |              |                 |                                      |
|------|----------------|---------|------------|-------------|-----------------|--------------|-----------------|--------------------------------------|
|      | Active         | Passive | Selectable |             |                 | NAMUR NE43   |                 | Max. load                            |
|      |                |         | Invert     | Range       | Limit           | Sensor error | Range 4...20 mA |                                      |
| 3101 | ✓              |         |            | 0/4...20 mA | 0/3.8...20.5 mA | 0/3.5/23 mA  | ✓               | ≤ 600 Ω                              |
| 3102 | ✓              |         |            | 0/4...20 mA | 0/3.8...20.5 mA | 0/3.5/23 mA  | ✓               | ≤ 600 Ω                              |
| 3111 | ✓              |         |            | 0/4...20 mA | 0/3.8...20.5 mA | 0/3.5/23 mA  | ✓               | ≤ 600 Ω                              |
| 3112 | ✓              |         |            | 0/4...20 mA | 0/3.8...20.5 mA | 0/3.5/23 mA  | ✓               | ≤ 600 Ω                              |
| 3113 | ✓              |         |            | 4...20 mA   | 0/3.8...20.5 mA | 0/3.5/23 mA  | ✓               | ≤ 600 Ω                              |
| 3331 |                | ✓       | ✓          | 4...20 mA   | 3.8...20.5 mA   | 3.5 / 23 mA  | ✓               | (V <sub>supply</sub> -5.5)/0.023 [Ω] |
| 3333 |                | ✓       | ✓          | 4...20 mA   | 3.8...20.5 mA   | 3.5 / 23 mA  | ✓               | (V <sub>supply</sub> -3.3)/0.023 [Ω] |
| 3337 |                | ✓       | ✓          | 4...20 mA   | 3.8...20.5 mA   | 3.5 / 23 mA  | ✓               | (V <sub>supply</sub> -6.2)/0.023 [Ω] |

Updating time . . . . . 10 ms  
 Load stability . . . . . ≤ 0.01% of span / 100 Ω

|                           | Selectable voltage output |                   |              |            |                  |              |           |
|---------------------------|---------------------------|-------------------|--------------|------------|------------------|--------------|-----------|
|                           | Low range                 |                   |              | High range |                  |              | Min. load |
|                           | Range                     | Limit             | Sensor error | Range      | Limit            | Sensor error |           |
| 3101, 3102,<br>3111, 3112 | 0/1...5 V                 | 0/0.875...5.125 V | 0/5.5 V      | 0/2...10 V | 0/1.75...10.25 V | 0/11 V       | 10 kΩ     |

of span = of the selected range

**Observed authority requirements:**

EMC. . . . . 2014/30/EU & UK SI 2016/1091  
 EMC Emission. . . . . CISPR 22, Class B  
 LVD. . . . . 2014/35/EU & UK SI 2016/1101  
 RoHS. . . . . 2011/65/EU & UK SI 2012/3032  
 ATEX. . . . . 2014/34/EU & UK SI 2016/1107  
 EAC. . . . . TR-CU 020/2011  
 EAC Ex. . . . . TR-CU 012/2011

**Approvals:**

DNV, Ships & Offshore. . . . . TAA00001RW  
 c UL us, UL 61010-1. . . . . E314307

**I.S. / Ex approvals:**

ATEX. . . . . KEMA 10ATEX0147 X  
 IECEx. . . . . KEM 10.0068 X  
 UKEX. . . . . DEKRA 21UKEX0055X  
 c FM us. . . . . FM17US0004X / FM17CA0003X  
 EAC Ex. . . . . RU C-DK.HA65.B.00355/19

# DIP-switch configuration

Applicable devices can be configured via DIP-switches. The DIP-switches are located on the side of the device and can be adjusted with a small screwdriver or other implement.

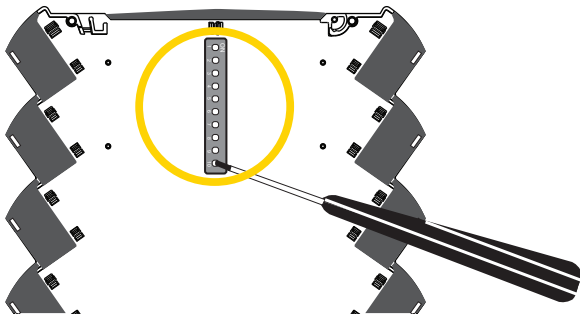

Default factory settings (with all DIP-switches in the OFF position):

|                      | 3102, 3112, 3331, 3333                              | 3101, 3111              | 3113, 3337  |
|----------------------|---|-------------------------|---|
| Sensor type          | Pt100, 3 wire                                       | TC K (int. CJC)         | Pt100, 3 wire                                       |
| Output range         | 4...20 mA   | 4...20 mA               | 4...20 mA   |
| Error detection      | Short circuit detection<br>Broken circuit detection | Short circuit detection | Short circuit detection<br>Broken circuit detection |
| Error output current | 3.5 mA  | 3.5 mA                  | 3.5 mA  |
| Noise suppression    | 50 Hz   | 50 Hz                   | 50 Hz   |
| Input lower limit    | 0°C   | 0°C                     | 0°C   |
| Input upper limit    | 150°C   | 600°C                   | 150°C   |
| Response time        | < 30 ms   | < 30 ms                 | < 60 ms   |
| Configuration mode   | -   | -                       | DIP switch configuration                            |

## DIP-switch settings

### 3101 and 3111 TC J & K

| Sensor                | S1 | 1 | 2       | 3  | Sensor Error Detection | S1 | 7 |
|-----------------------|----|---|---------|----|------------------------|----|---|
| TC J (int. cjc)       | ●  | ● | ●       | ●  | None                   |    |   |
| TC K (int. cjc)       | ●  | ● | ●       | ●  | Enable                 | ●  |   |
| TC J (ext. cjc)       | ●  | ● | ●       | ●  |                        |    |   |
| TC K (ext. cjc)       | ●  | ● | ●       | ●  |                        |    |   |
| Output                | S1 | 4 | 5       | 6  | Output Error Level     | S1 | 8 |
| 0...20 mA             |    |   |         |    | Downscale              |    |   |
| 4...20 mA             | ●  | ● | ●       | ●  | Upscale                | ●  |   |
| 0...10 V              |    |   |         |    |                        |    |   |
| 2...10 V              | ●  | ● | ●       | ●  |                        |    |   |
| 0...5 V               | ●  | ● | ●       | ●  |                        |    |   |
| 1...5 V               | ●  | ● | ●       | ●  |                        |    |   |
| ● = ON                |    |   |         |    |                        |    |   |
| Noise Supp.           | S1 | 9 | Resp.T. | S1 | 10                     |    |   |
| 50 Hz                 |    |   | < 30 ms |    |                        |    |   |
| 60 Hz                 | ●  |   | 300 ms  | ●  |                        |    |   |
| *3101 - only int. CJC |    |   |         |    |                        |    |   |

### 3102 and 3112 Pt100

| Sensor      | S1 | 1 | 2       | 3  | Sensor Error Detection | S1 | 7 |
|-------------|----|---|---------|----|------------------------|----|---|
| Pt100, 2w   | ●  | ● | ●       | ●  | None                   |    |   |
| Pt100, 3w   | ●  | ● | ●       | ●  | Enable                 | ●  |   |
| Pt100, 4w   | ●  | ● | ●       | ●  |                        |    |   |
| Output      | S1 | 4 | 5       | 6  | Output Error Level     | S1 | 8 |
| 0...20 mA   |    |   |         |    | Downscale              |    |   |
| 4...20 mA   | ●  | ● | ●       | ●  | Upscale                | ●  |   |
| 0...10 V    |    |   |         |    |                        |    |   |
| 2...10 V    | ●  | ● | ●       | ●  |                        |    |   |
| 0...5 V     | ●  | ● | ●       | ●  |                        |    |   |
| 1...5 V     | ●  | ● | ●       | ●  |                        |    |   |
| ● = ON      |    |   |         |    |                        |    |   |
| Noise Supp. | S1 | 9 | Resp.T. | S1 | 10                     |    |   |
| 50 Hz       |    |   | < 30 ms |    |                        |    |   |
| 60 Hz       | ●  |   | 300 ms  | ●  |                        |    |   |

### 3113 and 3337 Pt100 & TC J/K + HART

| Sensor          | S1 | 1  | 2       | 3  | Sensor Error Detection | S1 | 7 |
|-----------------|----|----|---------|----|------------------------|----|---|
| Pt100, 2w       | ●  | ●  | ●       | ●  | None                   |    |   |
| Pt100, 3w       | ●  | ●  | ●       | ●  | Enable                 | ●  |   |
| Pt100, 4w       | ●  | ●  | ●       | ●  |                        |    |   |
| TC J (Int. CJC) | ●  | ●  | ●       | ●  |                        |    |   |
| TC K (Int. CJC) | ●  | ●  | ●       | ●  |                        |    |   |
| TC J (Ext. CJC) | ●  | ●  | ●       | ●  |                        |    |   |
| TC K (Ext. CJC) | ●  | ●  | ●       | ●  |                        |    |   |
| Output          | S1 | 4  | 5       | 6  | Output Error Level     | S1 | 8 |
| 4...20 mA       | ●  | ●  | ●       | ●  | Downscale              |    |   |
| 20..4 mA        | ●  | ●  | ●       | ●  | Upscale                | ●  |   |
| ● = ON          |    |    |         |    |                        |    |   |
| Noise Supp.     | S1 | 9  | Resp.T. | S1 | 10                     |    |   |
| 50 Hz           |    |    | < 30 ms |    |                        |    |   |
| 60 Hz           | ●  |    | 300 ms  | ●  |                        |    |   |
| Config.         | S1 | 10 |         |    |                        |    |   |
| DIP             |    |    |         |    |                        |    |   |
| HART            | ●  |    |         |    |                        |    |   |

### 3331 Pt100 & TC J/K

| Sensor          | S1 | 1 | 2       | 3  | Sensor Error Detection | S1 | 7 |
|-----------------|----|---|---------|----|------------------------|----|---|
| Pt100, 2w       | ●  | ● | ●       | ●  | None                   |    |   |
| Pt100, 3w       | ●  | ● | ●       | ●  | Enable                 | ●  |   |
| Pt100, 4w       | ●  | ● | ●       | ●  |                        |    |   |
| TC J (int. CJC) | ●  | ● | ●       | ●  |                        |    |   |
| TC K (int. CJC) | ●  | ● | ●       | ●  |                        |    |   |
| TC J (Ext. CJC) | ●  | ● | ●       | ●  |                        |    |   |
| TC K (Ext. CJC) | ●  | ● | ●       | ●  |                        |    |   |
| Output          | S1 | 4 | 5       | 6  | Output Error Level     | S1 | 8 |
| 4...20 mA       | ●  | ● | ●       | ●  | Downscale              |    |   |
| 20..4 mA        | ●  | ● | ●       | ●  | Upscale                | ●  |   |
| ● = ON          |    |   |         |    |                        |    |   |
| Noise Supp.     | S1 | 9 | Resp.T. | S1 | 10                     |    |   |
| 50 Hz           |    |   | < 30 ms |    |                        |    |   |
| 60 Hz           | ●  |   | 300 ms  | ●  |                        |    |   |

### 3333 Pt100

| Sensor      | S1 | 1 | 2       | 3  | Sensor Error Detection | S1 | 7 |
|-------------|----|---|---------|----|------------------------|----|---|
| Pt100, 2w   | ●  | ● | ●       | ●  | None                   |    |   |
| Pt100, 3w   | ●  | ● | ●       | ●  | Enable                 | ●  |   |
| Pt100, 4w   | ●  | ● | ●       | ●  |                        |    |   |
| Output      | S1 | 4 | 5       | 6  | Output Error Level     | S1 | 8 |
| 4...20 mA   | ●  | ● | ●       | ●  | Downscale              |    |   |
| 20..4 mA    | ●  | ● | ●       | ●  | Upscale                | ●  |   |
| ● = ON      |    |   |         |    |                        |    |   |
| Noise Supp. | S1 | 9 | Resp.T. | S1 | 10                     |    |   |
| 50 Hz       |    |   | < 30 ms |    |                        |    |   |
| 60 Hz       | ●  |   | 300 ms  | ●  |                        |    |   |

Remember to cycle power for power rail / terminals to reload DIP-switch values at power up.

For easy DIP-switch programming, our DIP-switch configurator can be found at:  
[www.prelectronics.com/dip-switch-configurator/](http://www.prelectronics.com/dip-switch-configurator/)

## Temperature range programming

| DIP S2      |   |   |   | ● = ON |           |   |   |   |   |   |    |           |   | Temperature Range °C |   |   |   |    |           |   |   |   |   |   |    |
|-------------|---|---|---|--------|-----------|---|---|---|---|---|----|-----------|---|----------------------|---|---|---|----|-----------|---|---|---|---|---|----|
| Start Temp. | 1 | 2 | 3 | 4      | End Temp. | 5 | 6 | 7 | 8 | 9 | 10 | End Temp. | 5 | 6                    | 7 | 8 | 9 | 10 | End Temp. | 5 | 6 | 7 | 8 | 9 | 10 |
| -200        |   |   |   |        | 0         |   |   |   |   |   |    | 105       |   | ●                    | ● | ● |   |    | 375       | ● | ● | ● |   |   |    |
| -180        |   |   |   | ●      | 5         |   |   |   |   |   | ●  | 110       |   | ●                    | ● | ● |   |    | 400       | ● | ● | ● | ● |   |    |
| -150        |   |   | ● |        | 10        |   |   |   |   | ● |    | 115       |   | ●                    | ● | ● | ● |    | 450       | ● | ● | ● |   |   |    |
| -100        |   |   | ● | ●      | 15        |   |   |   |   | ● | ●  | 120       |   | ●                    | ● |   |   |    | 500       | ● | ● | ● | ● |   |    |
| -50         |   | ● | ● |        | 20        |   |   |   | ● |   |    | 125       |   | ●                    | ● |   | ● |    | 550       | ● | ● | ● | ● |   |    |
| -25         |   | ● | ● | ●      | 25        |   |   |   | ● | ● |    | 130       |   | ●                    | ● | ● |   |    | 600       | ● | ● | ● | ● | ● |    |
| -10         |   | ● | ● |        | 30        |   |   |   | ● | ● |    | 135       |   | ●                    | ● | ● | ● |    | 650       | ● | ● |   |   |   |    |
| -5          |   | ● | ● | ●      | 35        |   |   |   | ● | ● | ●  | 140       |   | ●                    | ● | ● |   |    | 700       | ● | ● |   |   |   | ●  |
| 0           | ● |   |   |        | 40        |   |   |   | ● |   |    | 145       |   | ●                    | ● | ● | ● |    | 750       | ● | ● |   | ● |   |    |
| 5           | ● |   |   | ●      | 45        |   |   |   | ● |   | ●  | 150       |   | ●                    | ● | ● | ● |    | 800       | ● | ● |   | ● | ● |    |
| 10          | ● |   | ● |        | 50        |   |   |   | ● | ● |    | 160       |   | ●                    | ● | ● | ● | ●  | 850       | ● | ● | ● |   |   |    |
| 20          | ● |   | ● | ●      | 55        |   |   |   | ● | ● | ●  | 170       | ● |                      |   |   |   |    | 900       | ● | ● | ● | ● |   | ●  |
| 25          | ● | ● |   |        | 60        |   |   |   | ● | ● |    | 180       | ● |                      |   |   | ● |    | 950       | ● | ● | ● | ● |   |    |
| 50          | ● | ● |   | ●      | 65        |   |   |   | ● | ● | ●  | 190       | ● |                      |   |   |   |    | 1000      | ● | ● | ● | ● | ● | ●  |
| 100         | ● | ● | ● |        | 70        |   |   |   | ● | ● | ●  | 200       | ● |                      |   |   | ● |    | 1050      | ● | ● | ● |   |   |    |
| 200         | ● | ● | ● | ●      | 75        |   |   |   | ● | ● | ●  | 225       | ● |                      |   | ● |   |    | 1100      | ● | ● | ● |   | ● |    |
|             |   |   |   |        | 80        |   | ● |   |   |   |    | 250       | ● |                      |   | ● | ● |    | 1150      | ● | ● | ● | ● |   |    |
|             |   |   |   |        | 85        |   | ● |   |   | ● |    | 275       | ● |                      |   | ● | ● |    | 1200      | ● | ● | ● | ● | ● |    |
|             |   |   |   |        | 90        |   | ● |   |   | ● | ●  | 300       | ● |                      |   | ● | ● | ●  | 1250      | ● | ● | ● | ● |   |    |
|             |   |   |   |        | 95        |   | ● |   |   | ● | ●  | 325       | ● | ●                    |   |   |   |    | 1300      | ● | ● | ● | ● | ● |    |
|             |   |   |   |        | 100       |   | ● | ● |   |   |    | 350       | ● | ●                    |   |   | ● |    | 1350      | ● | ● | ● | ● | ● |    |
|             |   |   |   |        |           |   |   |   |   |   |    |           |   |                      |   |   |   |    | 1372      | ● | ● | ● | ● | ● | ●  |

|              |                  |
|--------------|------------------|
| Sens. type : | Temp. range °C : |
| Pt100        | -200 - +850°C    |
| TC J         | -100 - +1200°C   |
| TC K         | -180 - +1372°C   |

Please note:

- 3101 and 3111 - only TC input available  
Valid TC J range: -100...+1200°C = correct DIP-switch setting  
Valid TC K range: -180...+1372°C = correct DIP-switch setting
- 3102, 3112 and 3333 - only Pt100 input available  
Valid Pt100 range: -200...+850°C = correct DIP-switch setting
- "Start temp" must be lower than "End temp" = correct DIP-switch setting
- Power must be cycled after DIP-switch positions are changed



## Operation & troubleshooting

The 3000 series devices provide multiple features for easy user operation and for performing efficient troubleshooting.

Monitoring the operational status is easy from the front LED.

### Status indicator front LED

For 3101, 3102, 3111, 3112 and 3113

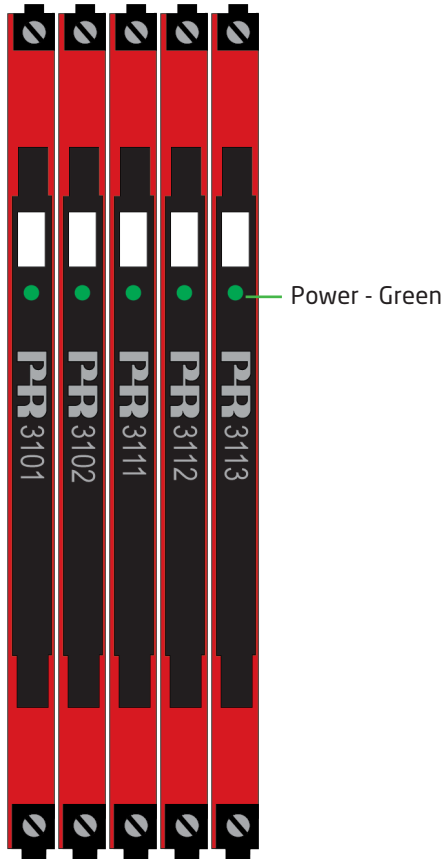

| Condition                    | LED                               | Output and loop supply | Action required                     |
|------------------------------|-----------------------------------|------------------------|-------------------------------------|
| No supply / device error     | OFF                               | De-energized           | Connect supply / replace device     |
| Power-up or restart          | 1 Flash<br>(0.5 s OFF + 0.5 s ON) | De-energized           | -                                   |
| Device OK                    | Flashing 13 Hz<br>(15 ms ON)      | Energized              | -                                   |
| Incorrect DIP-switch setting | Flashing 1 Hz<br>(500 ms ON)      | De-energized           | Correct setting and re-power device |
| Sensor error indication      | Flashing 1 Hz<br>(15 ms ON)       | Up- or Downscale       | Check sensor                        |

# Installation instructions

## UL installation

Use 60/75°C copper conductors only.

Wire size . . . . . AWG 26-12

UL file number . . . . . E314307

The device is an Open Type Listed Process Control Equipment. To prevent injury resulting from accessibility to live parts the equipment must be installed in an enclosure. The power Supply unit must comply with NEC Class 2, as described by the National Electrical Code® (ANSI / NFPA 70).

## IECEX, ATEX and UKEX installation in Zone 2

IECEX KEM 10.0068 X . . . . . Ex ec IIC T4 Gc

KEMA 10ATEX0147 X . . . . . I 3 G Ex ec IIC T4 Gc

DEKRA 21UKEX0055X . . . . . II 3 G Ex ec IIC T4 Gc

For safe installation, the following must be observed. The device shall only be installed by qualified personnel who are familiar with the national and international laws, directives and standards that apply to this area.

The devices shall be installed in a suitable enclosure providing a degree of protection of at least IP54 according to EN IEC 60079-0, taking into account the environmental conditions under which the equipment will be used.

When the temperature under rated conditions exceeds 70°C at the cable or conduit entry point, or 80°C at the branching point of the conductors, the temperature specification of the selected cable shall be in compliance with the actual measured temperature.

To prevent ignition of the explosive atmospheres, disconnect power before servicing and do not separate connectors when energized and an explosive gas mixture is present.

For installation on power rail in Zone 2, only Power Rail type 9400 supplied by Power Control Unit type 9410 is allowed.

Do not mount or remove devices from the power rail when an explosive gas mixture is present.

## cFmus installation in Division 2 or Zone 2

FM17CA0003X / FM17US0004X . . . . . Class I, Div. 2, Group A, B, C, D T4 or

Class I, Zone 2, AEx nA IIC T4 or Ex nA IIC T4

In class I, Division 2 or Zone 2 installations, the subject equipment shall be mounted within a tool-secured enclosure which is capable of accepting one or more of Class I, Division 2 wiring methods specified in the National Electrical Code (ANSI/NFPA 70) or in Canada in the Canadian Electrical Code (C22.1).

The 3000 System Isolators and Converters must be connected to limited output NEC Class 2 circuits, as outlined in the National Electrical Code® (ANSI / NFPA 70), only. If the devices are connected to a redundant power supply (two separate power supplies), both must meet this requirement.

Where installed in outdoor or potentially wet locations the enclosure shall at a minimum meet the requirements of IP54.

**Warning:** Substitution of components may impair suitability for zone 2 / division 2.

**Warning:** To prevent ignition of the explosive atmospheres, disconnect power before servicing and do not separate connectors when energised and an explosive gas mixture is present.

**Warning:** Do not mount or remove devices from the power rail when an explosive gas mixture is present.

## Document history

The following list provides notes concerning revisions of this document.

| <b>Rev. ID</b> | <b>Date</b> | <b>Notes</b>   |
|----------------|-------------|--|
| 103            | 1803        | Models 31xx-N added.<br>Specifications for max. required power and power dissipation added.<br>PESO/CCOE approval added. |
| 104            | 2037        | EAC Ex approval added.<br>PESO/CCOE approval discontinued .  |
| 105            | 2108        | ATEX and IECEx approvals updated - Ex na changed to Ex ec.   |
| 106            | 2205        | Side label updated.<br>UKEX approval added.  |

# We are near you, *all over the world*

**Our trusted red boxes are supported wherever you are**

All our devices are backed by expert service and a 5-year warranty. With each product you purchase, you receive personal technical support and guidance, day-to-day delivery, repair without charge within the warranty period and easily accessible documentation.

We are headquartered in Denmark, and have offices and authorized partners the world over. We are a local

business with a global reach. This means that we are always nearby and know your local markets well. We are committed to your satisfaction and provide **PERFORMANCE MADE SMARTER** all around the world.

For more information on our warranty program, or to meet with a sales representative in your region, visit [prelectronics.com](http://prelectronics.com).

# Benefit today from *PERFORMANCE MADE SMARTER*

PR electronics is the leading technology company specialized in making industrial process control safer, more reliable and more efficient. Since 1974, we have been dedicated to perfecting our core competence of innovating high precision technology with low power consumption. This dedication continues to set new standards for products communicating, monitoring and connecting our customers' process measurement points to their process control systems.

Our innovative, patented technologies are derived from our extensive R&D facilities and from having a great understanding of our customers' needs and processes. We are guided by principles of simplicity, focus, courage and excellence, enabling some of the world's greatest companies to achieve PERFORMANCE MADE SMARTER.