

PERFORMANCE
MADE
SMARTER

Product manual

5715

Programmable LED indicator



TEMPERATURE | I.S. INTERFACES | COMMUNICATION INTERFACES | MULTIFUNCTIONAL | ISOLATION | DISPLAY

No. 5715V104-UK
From serial no: 191083001

PR
electronics

6 Product Pillars

to meet your every need

Individually outstanding, unrivalled in combination

With our innovative, patented technologies, we make signal conditioning smarter and simpler. Our portfolio is composed of six product areas, where we offer a wide range of analog and digital devices covering over a thousand applications in industrial and factory automation. All our products comply with or surpass the highest industry standards, ensuring reliability in even the harshest of environments and have a 5-year warranty for greater peace of mind.



Our range of temperature transmitters and sensors provides the highest level of signal integrity from the measurement point to your control system. You can convert industrial process temperature signals to analog, bus or digital communications using a highly reliable point-to-point solution with a fast response time, automatic self-calibration, sensor error detection, low drift, and top EMC performance in any environment.



We deliver the safest signals by validating our products against the toughest safety standards. Through our commitment to innovation, we have made pioneering achievements in developing I.S. interfaces with SIL 2 Full Assessment that are both efficient and cost-effective. Our comprehensive range of analog and digital intrinsically safe isolation barriers offers multifunctional inputs and outputs, making PR an easy-to-implement site standard. Our backplanes further simplify large installations and provide seamless integration to standard DCS systems.



We provide inexpensive, easy-to-use, future-ready communication interfaces that can access your PR installed base of products. All the interfaces are detachable, have a built-in display for readout of process values and diagnostics, and can be configured via push-buttons. Product specific functionality includes communication via Modbus and Bluetooth and remote access using our PR Process Supervisor (PPS) application, available for iOS and Android.



Our unique range of single devices covering multiple applications is easily deployable as your site standard. Having one variant that applies to a broad range of applications can reduce your installation time and training, and greatly simplify spare parts management at your facilities. Our devices are designed for long-term signal accuracy, low power consumption, immunity to electrical noise and simple programming.



Our compact, fast, high-quality 6 mm isolators are based on microprocessor technology to provide exceptional performance and EMC-immunity for dedicated applications at a very low total cost of ownership. They can be stacked both vertically and horizontally with no air gap separation between units required.



Our display range is characterized by its flexibility and stability. The devices meet nearly every demand for display readout of process signals and have universal input and power supply capabilities. They provide a real-time measurement of your process value no matter the industry and are engineered to provide a user-friendly and reliable relay of information, even in demanding environments.

Programmable LED indicator 5715

Table of contents

| | |
|---|----|
| Warning | 4 |
| Symbol identification | 4 |
| Safety instructions | 5 |
| Front and back layout | 6 |
| Application | 7 |
| Technical characteristics | 7 |
| Mounting / installation | 7 |
| Applications | 8 |
| Order | 9 |
| Electrical specifications | 9 |
| Sensor error detection / sensor error detection outside range | 12 |
| Connections | 14 |
| Block diagram | 15 |
| Routing diagram | 17 |
| Scrolling help text | 18 |
| Configuration / operating the function keys | 20 |
| Programming via PC | 21 |
| Graphic depiction of the relay function setpoint | 21 |
| Installation instructions | 22 |
| Document history | 23 |

Warning



GENERAL

This device is designed for connection to hazardous electric voltages. Ignoring this warning can result in severe personal injury or mechanical damage. To avoid the risk of electric shock and fire, the safety instructions of this manual must be observed and the guidelines followed. The specifications must not be exceeded, and the device must only be applied as described in the following. Prior to the commissioning of the device, this manual must be examined carefully. Only qualified personnel (technicians) should install this device. If the equipment is used in a manner not specified by the manufacturer, the protection provided by the equipment may be impaired.

Warning



**HAZARDOUS
VOLTAGE**

Until the device is fixed, do not connect hazardous voltages to the device. The following operations should only be carried out on a disconnected device and under ESD-safe conditions:
Troubleshooting the device.



Repair of the device must be done by PR electronics A/S only.

Symbol identification



Triangle with an exclamation mark: Warning /demand. Potentially lethal situations. Read the manual before installation and commissioning of the device in order to avoid incidents that could lead to personal injury or mechanical damage.



The CE mark proves the compliance of the device with the essential requirements of the EU directives.



The UKCA mark proves the compliance of the device with the essential requirements of the UK regulations.



The double insulation symbol shows that the device is protected by double or reinforced insulation.

Safety instructions

Definitions

Hazardous voltages have been defined as the ranges: 75 to 1500 Volt DC, and 50 to 1000 Volt AC.

Technicians are qualified persons educated or trained to mount, operate, and also trouble-shoot technically correct and in accordance with safety regulations.

Operators, being familiar with the contents of this manual, adjust and operate the knobs or potentiometers during normal operation.

Receipt and unpacking

Unpack the device without damaging it and check whether the device type corresponds to the one ordered. The packing should always follow the device until this has been permanently mounted.

Environment

Avoid direct sun light, dust, high temperatures, mechanical vibrations and shock, and rain and heavy moisture. If necessary, heating in excess of the stated limits for ambient temperatures should be avoided by way of ventilation.

The device must be installed in pollution degree 2 or better.

The device is designed to be safe at least under an altitude up to 2000 m.

The device is designed for indoor use.

Mounting

Only technicians, who are familiar with the technical terms, warnings, and instructions in the manual and who are able to follow these, should connect the device. Should there be any doubt as to the correct handling of the device, please contact your local distributor or, alternatively,

PR electronics A/S
www.prelectronics.com

Mounting and connection of the device should comply with national legislation for mounting of electric materials, i.e. wire cross section, protective fuse, and location. Descriptions of input / output and supply connections are shown in the block diagram and side label.

Stranded wire should be installed with an insulation stripping length of 5 mm or via a suitable insulated terminal such as a bootlace ferrule.

The following apply to fixed hazardous voltages-connected devices:

The max. size of the protective fuse is 10 A and, together with a power switch, it should be easily accessible and close to the device. The power switch should be marked with a label telling it will switch off the voltage to the device.

Year of manufacture can be taken from the first two digits in the serial number.

Calibration and adjustment

During calibration and adjustment, the measuring and connection of external voltages must be carried out according to the specifications of this manual. The technician must use tools and instruments that are safe to use.

Normal operation

Operators are only allowed to adjust and operate devices that are safely fixed in panels, etc., thus avoiding the danger of personal injury and damage. This means there is no electrical shock hazard, and the device is easily accessible.

Cleaning

When disconnected, the device may be cleaned with a cloth moistened with distilled water.

Liability

To the extent the instructions in this manual are not strictly observed, the customer cannot advance a demand against PR electronics A/S that would otherwise exist according to the concluded sales agreement.

Front and back layout



Picture 1: Front of 5715.

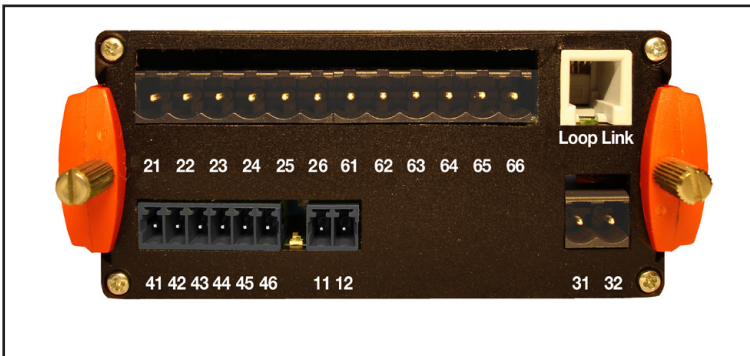

Picture 2: Back of 5715.

Programmable LED indicator 5715

- 4-digit 14-segment LED display
- Input for mA, V, potentiometer, Ohm, RTD and TC
- 4 relays and analog output
- Universal supply
- Programmable via front keys and PC

Application

- Display for digital readout of current / voltage / resistance / temperature or 3-wire potentiometer signals.
- Process control with 4 pairs of potential-free change-over relays and analog output.
- For tank level control, with the possibility of customer linearisation ensuring correct level measurement and control in non-linear tanks.

Technical characteristics

- 4-digit LED indicator with 13.8 mm 14-segment characters. Max. display readout -1999...9999 with programmable decimal point and relay ON / OFF indication.
- 2.3 kVAC galvanic isolation between input, output and supply.
- All standard operational parameters can be adjusted to any application by way of the front function keys. When programming is carried out by way of a PC and the configuration program PReset, additional configuration options are available, such as customer-defined linearisation and special input signals.
- Help texts in eight languages can be selected via a menu item.
- A menu item allows the user to minimise the installation test time for the relay outputs by activating / deactivating each relay independently of the input signal.

Mounting / installation

- To be mounted in panel front. The included rubber packing must be mounted between the panel cutout hole and the display front to obtain a protection degree of IP65 (type 4X). For extra protection in extreme environments, PR 5715 can be delivered with a specially designed splash-proof cover as accessory.

Applications

Input signals:

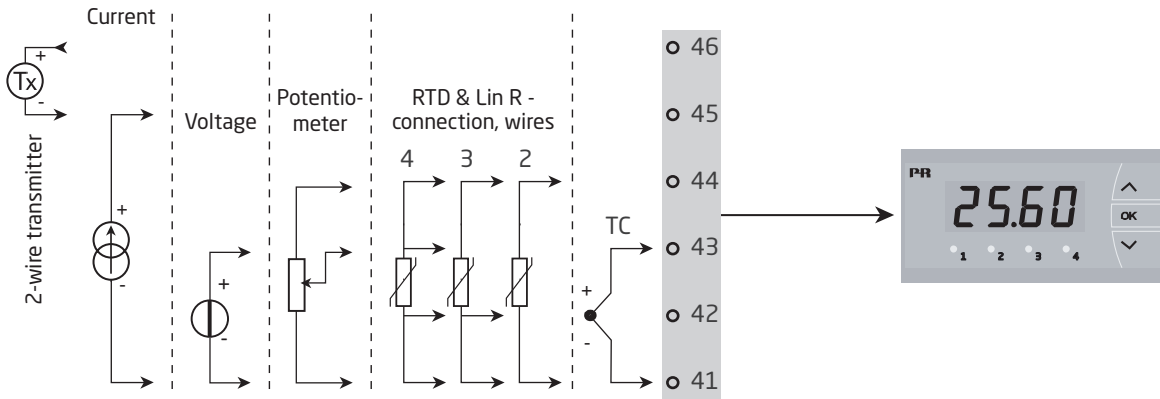

Output signals:

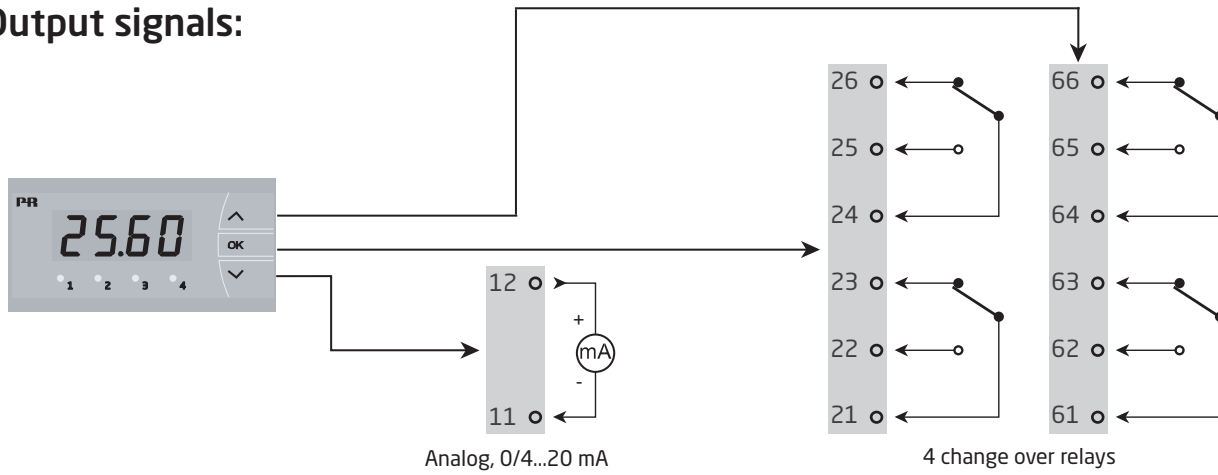

Supply:

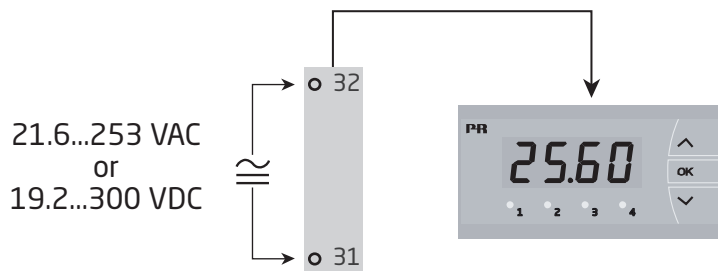

| Basic values | | |
|---------------------------------|------------------------------|--|
| Input type | Basic accuracy | Temperature coefficient |
| mA | $\leq \pm 4 \mu\text{A}$ | $\leq \pm 0.4 \mu\text{A} / ^\circ\text{C}$ |
| Volt | $\leq \pm 20 \mu\text{V}$ | $\leq \pm 2 \mu\text{V} / ^\circ\text{C}$ |
| Pt100 | $\leq \pm 0.2^\circ\text{C}$ | $\leq \pm 0.01^\circ\text{C} / ^\circ\text{C}$ |
| Linear resistance | $\leq \pm 0.1^\circ\Omega$ | $\leq \pm 0.01 \Omega / ^\circ\text{C}$ |
| Potentiometer | $\leq \pm 0.1^\circ\Omega$ | $\leq \pm 0.01 \Omega / ^\circ\text{C}$ |
| TC type: E, J, K, L, N, T, U | $\leq \pm 1^\circ\text{C}$ | $\leq \pm 0.05^\circ\text{C} / ^\circ\text{C}$ |
| TC type: R, S, W3, W5, Lr | $\leq \pm 2^\circ\text{C}$ | $\leq \pm 0.2^\circ\text{C} / ^\circ\text{C}$ |
| TC type: B 85...200°C | $\leq \pm 4^\circ\text{C}$ | $\leq \pm 0.4^\circ\text{C} / ^\circ\text{C}$ |
| TC type: B 200...1820°C | $\leq \pm 2^\circ\text{C}$ | $\leq \pm 0.2^\circ\text{C} / ^\circ\text{C}$ |

EMC - immunity influence. $< \pm 0.5\%$ of readout

Auxiliary supply:

2 wire supply, pin 46...45. $> 15 \text{ VDC} @ 0...20 \text{ mA}$

TC input

| Type | Min. value | Max. value | Standard |
|------|------------|------------|--------------|
| B | 0°C | +1820°C | IEC 60584-1 |
| E | -100°C | +1000°C | IEC 60584-1 |
| J | -100°C | +1200°C | IEC 60584-1 |
| K | -180°C | +1372°C | IEC 60584-1 |
| L | -200°C | +900°C | DIN 43710 |
| N | -180°C | +1300°C | IEC 60584-1 |
| R | -50°C | +1760°C | IEC 60584-1 |
| S | -50°C | +1760°C | IEC 60584-1 |
| T | -200°C | +400°C | IEC 60584-1 |
| U | -200°C | +600°C | DIN 43710 |
| W3 | 0°C | +2300°C | ASTM E988-90 |
| W5 | 0°C | +2300°C | ASTM E988-90 |
| Lr | -200°C | +800°C | GOST 3044-84 |

Cold junction compensation (CJC) via internal sensor $\pm(2.0^\circ\text{C} + 0.4^\circ\text{C} * \Delta t)$

$\Delta t = \text{internal temperature} - \text{ambient temperature}$

Sensor error detection, all TC types. Yes

Sensor error current:

when detecting Nom. 2 μA

else. 0 μA

RTD, linear resistance and potentiometer input

| Input type | Min. value | Max. value | Standard |
|---------------|-------------|----------------|--------------------|
| Pt10...Pt1000 | -200°C | +850°C | IEC 60751 |
| Ni50...Ni1000 | -60°C | +250°C | DIN 43760 |
| Cu10...Cu100 | -200°C | +260°C | $\alpha = 0.00427$ |
| Lin. R | 0 Ω | 10000 Ω | - |
| Potentiometer | 10 Ω | 100 k Ω | - |

Input for RTD types:

Pt10, Pt20, Pt50, Pt100, Pt200, PT250, Pt300, Pt400, Pt500, Pt1000

Ni50, Ni100, Ni120, Ni1000, Cu10, Cu20, Cu50, Cu100

Cable resistance pr. wire, RTD (max.) 50 Ω

Sensor current, RTD Nom. 0.2 mA

Effect of sensor cable resistance (3- / 4-wire), RTD < 0.002 Ω / Ω

Sensor error detection, RTD Yes

Short circuit detection, RTD < 15 Ω

Current input

Measurement range 0...23 mA

Programmable measurement ranges 0...20 and 4...20 mA

Input resistance Nom. 20 Ω + PTC 25 Ω

Sensor error detection:

loop break 4...20 mA Yes

Voltage input

Measurement range 0...12 VDC

Programmable measurement ranges 0...1 / 0.2...1 / 0...10 / 2...10 VDC

Input resistance Nom. 10 M Ω

Outputs

Display

Display readout -1999...9999 (4 digits)

Decimal point Programmable

Digit height 13.8 mm

Display updating 2.2 times / s

Input outside input range is indicated by Explanatory text

Current output

Signal range (span) 0...23 mA

Programmable signal ranges 0...20 / 4...20 / 20...0 / 20...4 mA

Load (max.) \leq 800 Ω

Load stability \leq 0.01% of span / 100 Ω

Sensor error detection 0 / 3.5 / 23 mA / none

NAMUR NE 43 up / downscale 23 mA / 3.5 mA

Output limitation:

on 4...20 and 20...4 mA signals 3,8...20.5 mA

on 0...20 and 20...0 mA signals 0...20.5 mA

Current limit. \leq 28 mA

Relay outputs

| | |
|--|--|
| Relay function | Setpoint |
| Hysteresis. | 0...100% |
| On and Off delay | 0...3600 s |
| Sensor error detection | Make / Break / Hold |
| Max. voltage | 250 VAC / VDC |
| Max. AC current. | 2 A / AC |
| Max. AC power | 500 VA |
| Max. DC current, resistive load: | |
| @ $U_{\text{relay}} \leq 30$ VDC | 2 ADC |
| @ $U_{\text{relay}} > 30$ VDC. | $[1380 \times U_{\text{relay}}^{-2} \times 1.0085^{U_{\text{relay}}}]$ ADC |

Graphic depiction of $[1380 \times U_{\text{relay}}^{-2} \times 1.0085^{U_{\text{relay}}}]$:

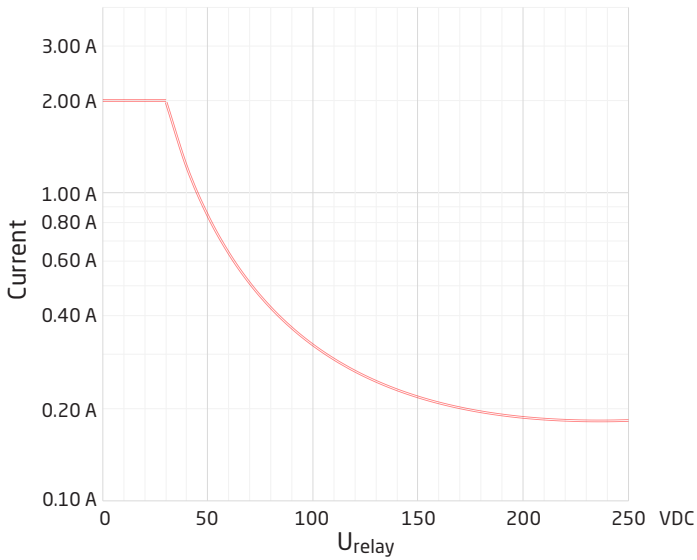

Observed authority requirements

| | |
|-------------------|------------------------------|
| EMC. | 2014/30/EU & UK SI 2016/1091 |
| LVD | 2014/35/EU & UK SI 2016/1101 |
| RoHS | 2011/65/EU & UK SI 2012/3032 |
| EAC | TR-CU 020/2011 |
| EAC LVD | TR-CU 004/2011 |

Approvals

| | |
|--|------------|
| EU RO Mutual Recognition Type Approval | MRA000000Z |
| c UL us, UL 508. | E248256 |

Sensor error detection / sensor error detection outside range

| Sensor error check in 5715 variants | | |
|-------------------------------------|--|------------------------|
| Variant | Configuration | Sensor error detection |
| 5715B | ERR1, ERR2, ERR3 and ERR4 = NONE | OFF |
| | else: | ON |
| 5715D | ERR1, ERR2, ERR3 and ERR4=NONE, O.ERR=NONE | OFF |
| | else: | ON |

| Outside range readout (IN.LO, IN.HI): If the valid range of the A/D converter or the polynomial is exceeded | | | |
|--|-----------------------|----------------|--------------------------|
| Input | Range | Readout | Limit |
| VOLT | 0...1 V / 0.2...1 V | IN.LO | < -25 mV |
| | | IN.HI | > 1.2 V |
| | 0...10 V / 2...10 V | IN.LO | < -25 mV |
| | | IN.HI | > 12 V |
| CURR | 0...20 mA / 4...20 mA | IN.LO | < -1.05 mA |
| | | IN.HI | > 25.05 mA |
| POTM | - | IN.LO | < -0.5% |
| | | IN.HI | > 100.5% |
| TEMP | TC / RTD | IN.LO | < temperature range -2°C |
| | | IN.HI | > temperature range +2°C |
| LIN. R | 0...800 ohm | IN.LO | < 0 ohm |
| | | IN.HI | > 1 kohm |
| | 0...10 kohm | IN.LO | < 0 ohm |
| | | IN.HI | > 15 kohm |

| Sensor error detection (SE.BR, SE.SH) | | | |
|--|--|----------------|---------------------------|
| Input | Range | Readout | Limit |
| CURR | Loop break (4...20 mA) | SE.BR | <= 3.6 mA; > = 21 mA |
| TEMP | TC | SE.BR | > ca. 750 kohm / (1.25 V) |
| | RTD, 2-, 3- & 4-wire No SE.SH for Cuxx, Pt10, Pt20 & Pt50 | SE.BR | > 12 kohm |
| | | SE.SH | < 15 ohm |
| LIN. R | 0...800 ohm | SE.BR | > 875 ohm |
| | 0...10 kohm | SE.BR | > 12 kohm |

| Display readout below min. / above max. (-1.9.9.9, 9.9.9.9) | | | |
|--|--------------|----------------|------------------------|
| Input | Range | Readout | Limit |
| CURR / VOLT / LIN. R | All | -1.9.9.9 | Display readout <-1999 |
| | | 9.9.9.9 | Display readout >9999 |
| POTM | - | -1.9.9.9 | Display readout <-1999 |
| | | 9.9.9.9 | Display readout >9999 |

| Readout at hardware error | | |
|---|----------------|------------------------|
| Error search | Readout | Cause |
| Test of internal communication μ C / ADC | HW.ER | Permanent error in ADC |
| Test of internal CJC sensor | CJ.ER | CJC sensor defect |
| Check-sum test of the configuration in RAM | RA.ER | Error in RAM |
| Check-sum test of the configuration in EEPROM | EE.ER | Error in EEPROM |

! Error indications in the display blink once a second. The help text explains the error.

Connections

Supply:

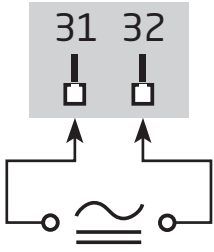

Inputs:

RTD & Lin R, 2-wire

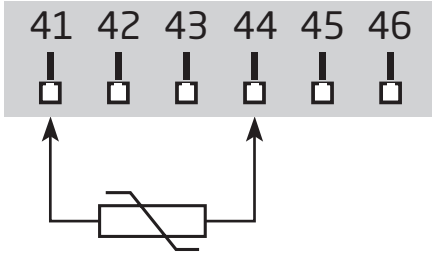

RTD & Lin R, 3-wire

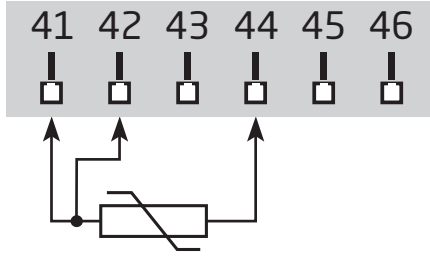

RTD & Lin R, 4-wire

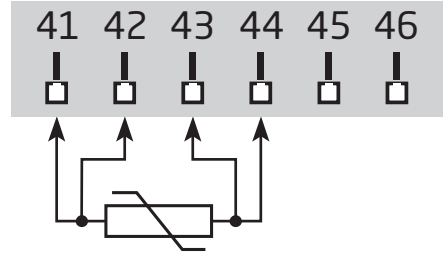

TC

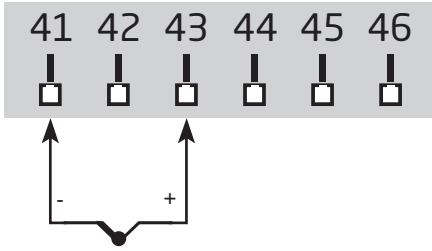

2-wire transmitter

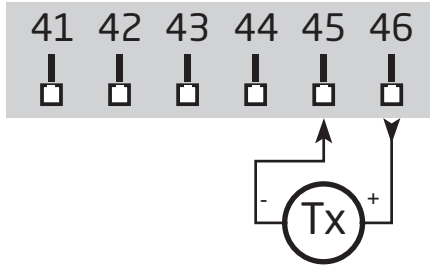

Current

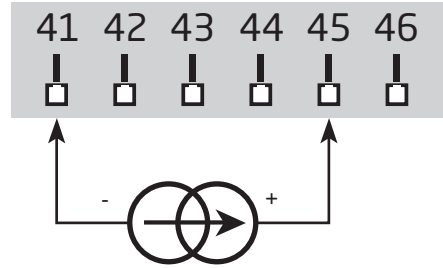

Voltage

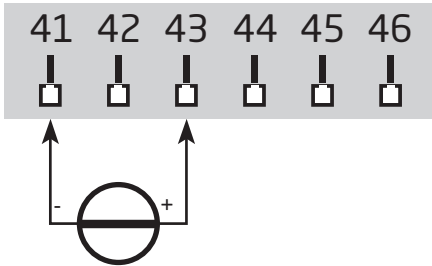

Potentiometer

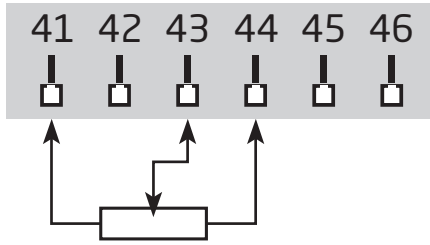

Output:

Current

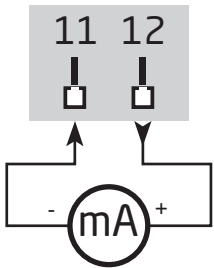

Relays

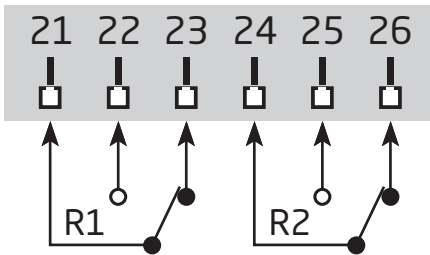

Relays

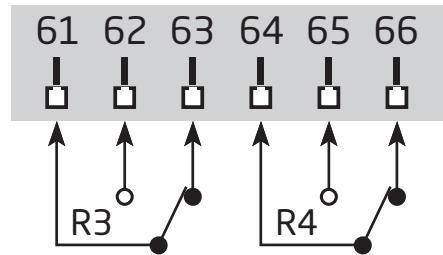

Block diagram

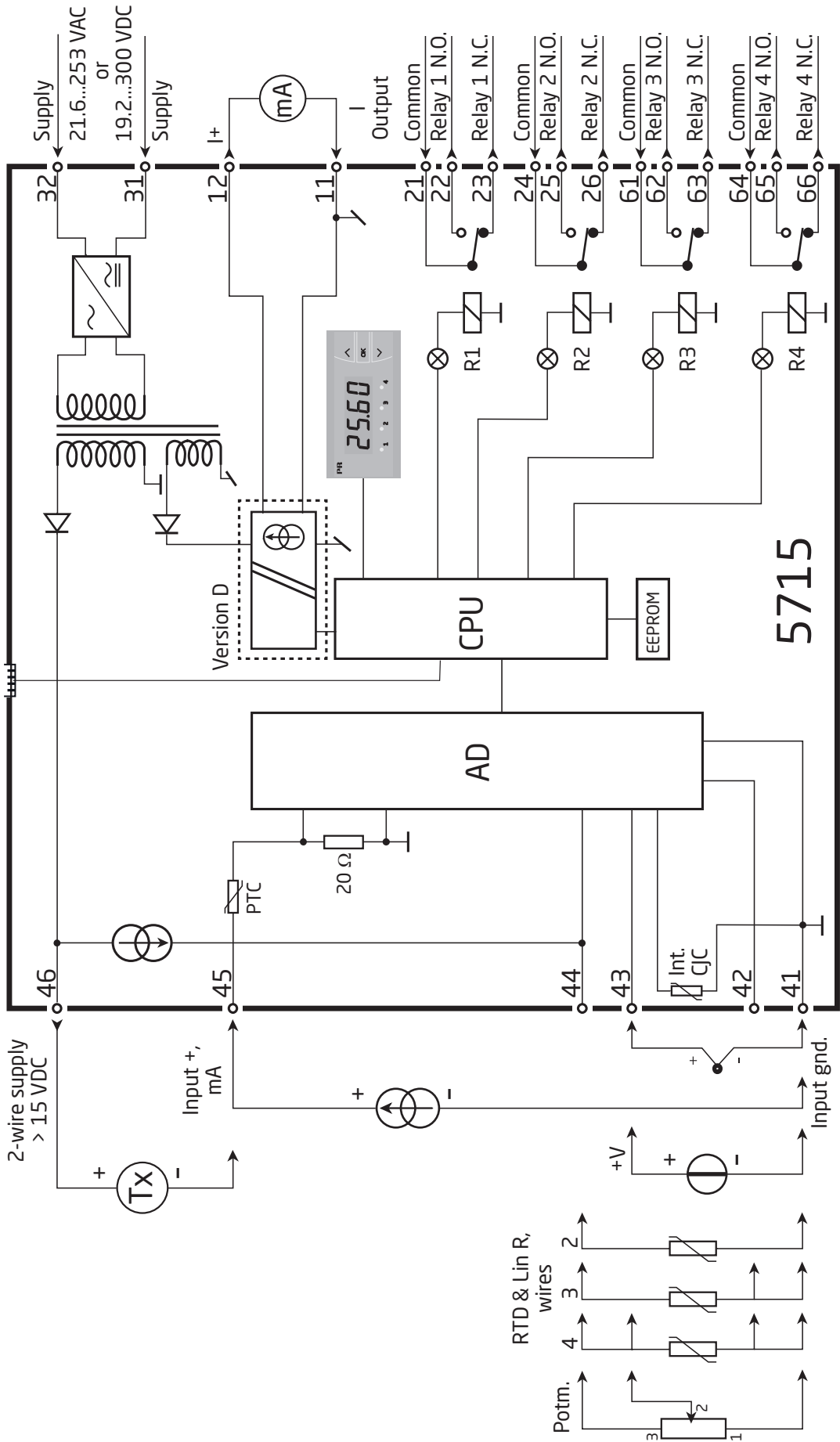

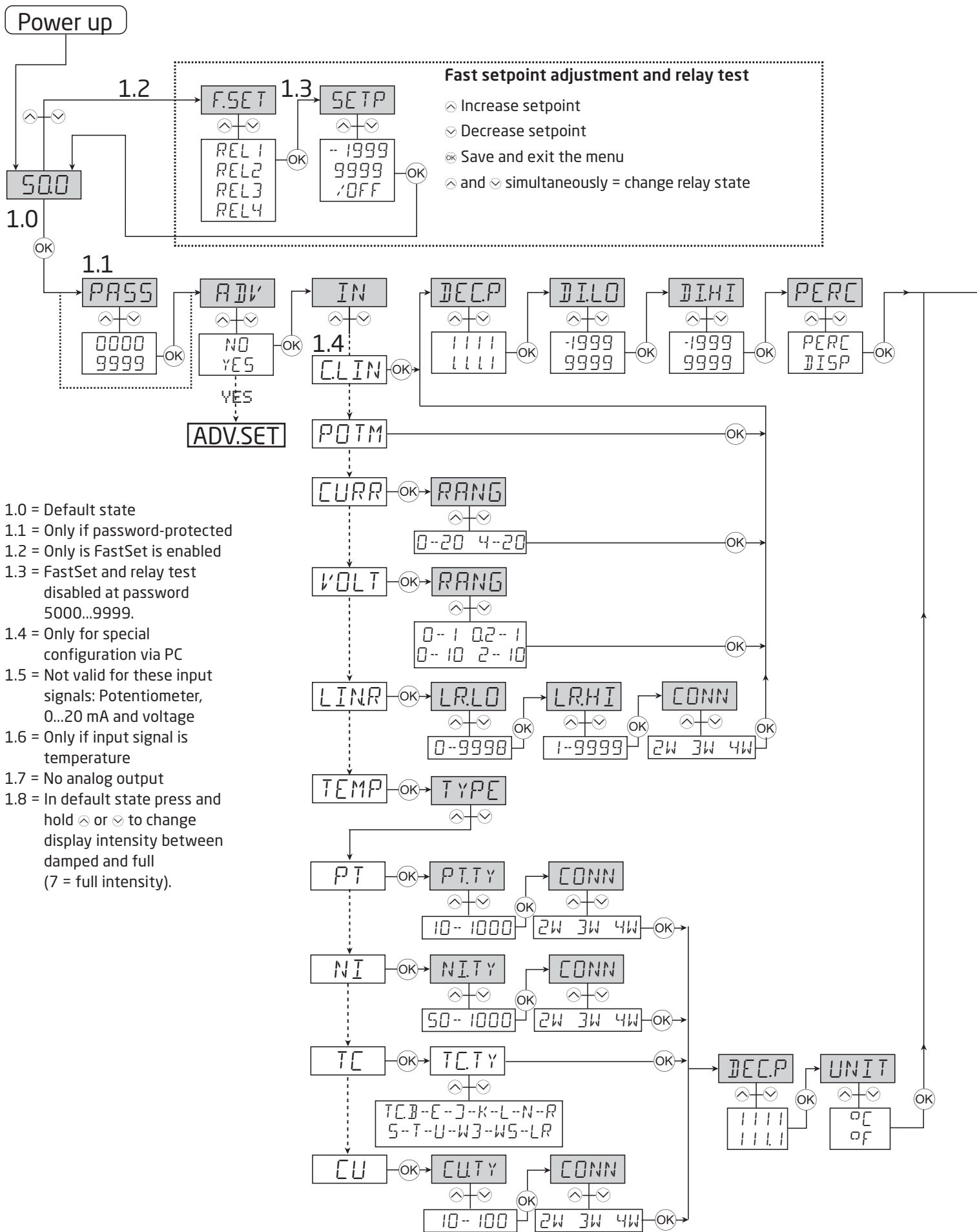

Routing diagram

If no keys are activated for 2 minutes the display returns to default state 1.0 without saving configuration changes.

⬆ Increase value / choose next parameter.

⬇ Decrease value / choose previous parameter.

⊞ Accept the chosen parameter and go to the next menu.

Hold ⊞ Back to previous menu / return to menu 1.0 without saving.

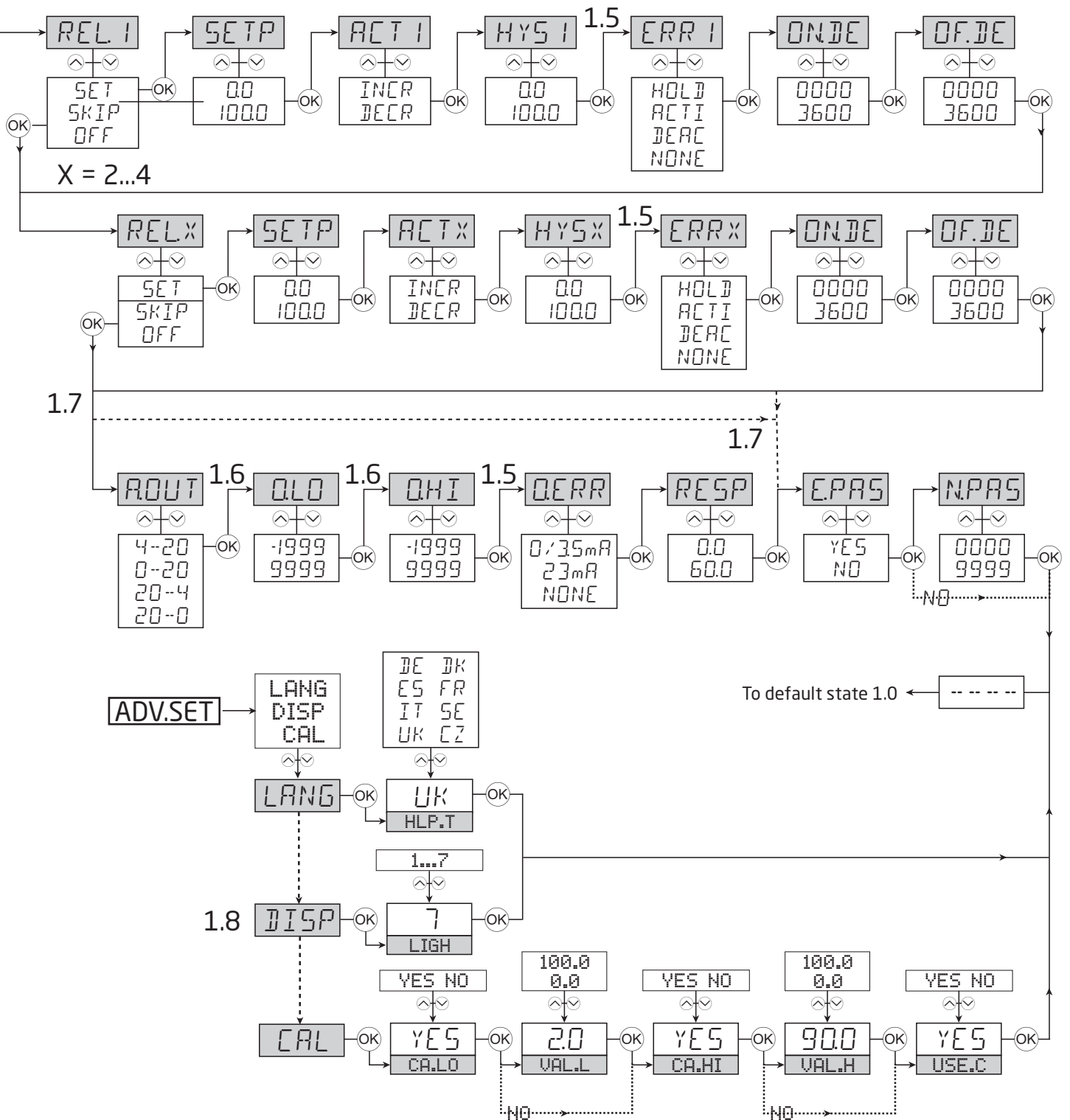

Scrolling help text

Display in default state xxxx, hardware error:

SE.BR --> SENSOR WIRE BREAKAGE
SE.SH --> SENSOR SHORT CIRCUIT
IN.HI --> INPUT OVERRANGE
IN.LO --> INPUT UNDERRANGE
9.9.9.9 --> DISPLAY OVERRANGE
-1.9.9.9 --> DISPLAY UNDERRANGE
HW.ER --> HARDWARE ERROR
EE.ER --> EEPROM ERROR - CHECK CONFIGURATION
RA.ER --> RAM MEMORY ERROR
CJ.ER --> CJC SENSOR ERROR

Fastset (Enabled):

F.SET
REL1 --> FAST SET MENU -
REL2 --> SELECT RELAY
REL3
REL4

SETP
 xxxx --> RELAY SETPOINT - PRESS OK TO SAVE

Fastset (Disabled):

SETP
 xxxx --> RELAY SETPOINT - READ ONLY

Configuration menus:

ADV
YES --> ENTER ADVANCED SETUP MENU?
NO

PASS
 xxxx --> SET CORRECT PASSWORD

IN
C.LIN* --> TEXT ENTERED BY USER IN PRESET
CURR --> CURRENT INPUT
VOLT --> VOLTAGE INPUT
POTM --> POTENTIOMETER INPUT
LIN.R --> LINEAR RESISTANCE INPUT
TEMP --> TEMPERATURE SENSOR INPUT

RANG **When current selected:**
 0-20 --> INPUT RANGE IN mA
 4-20 --> INPUT RANGE IN mA

RANG **When voltage selected:**
 0-10 --> INPUT RANGE IN VOLT
 2-10 --> INPUT RANGE IN VOLT
 0.0-1 --> INPUT RANGE IN VOLT
 0.2-1 --> INPUT RANGE IN VOLT

DEC.P
 1111 --> DECIMAL POINT POSITION
 111.1 --> DECIMAL POINT POSITION
 11.11 --> DECIMAL POINT POSITION
 1.111 --> DECIMAL POINT POSITION

LR.LO
 xxxx --> SET RESISTANCE VALUE LOW

LR.HI
 xxxx --> SET RESISTANCE VALUE HIGH

DI.LO
 xxxx --> DISPLAY READOUT LOW

DI.HI
 xxxx --> DISPLAY READOUT HIGH

REL.U
PERC --> SET RELAY IN PERCENTAGE
DISP --> SET RELAY IN DISPLAY UNITS

TYPE
CU --> SELECT CU SENSOR TYPE
PT --> SELECT PT SENSOR TYPE
NI --> SELECT NI SENSOR TYPE
TC --> SELECT TC SENSOR TYPE

CU.TY
 10 --> SELECT CU SENSOR TYPE
 20 --> SELECT CU SENSOR TYPE
 50 --> SELECT CU SENSOR TYPE
 100 --> SELECT CU SENSOR TYPE

PT.TY
 10 --> SELECT PT SENSOR TYPE
 20 --> SELECT PT SENSOR TYPE
 50 --> SELECT PT SENSOR TYPE
 100 --> SELECT PT SENSOR TYPE
 200 --> SELECT PT SENSOR TYPE
 250 --> SELECT PT SENSOR TYPE
 300 --> SELECT PT SENSOR TYPE
 400 --> SELECT PT SENSOR TYPE
 500 --> SELECT PT SENSOR TYPE
 1000 --> SELECT PT SENSOR TYPE

NI.TY
 50 --> SELECT NI SENSOR TYPE
 100 --> SELECT NI SENSOR TYPE
 120 --> SELECT NI SENSOR TYPE
 1000 --> SELECT NI SENSOR TYPE

CONN When Cu, Pt and Ni sensor is selected
2W --> SELECT 2-WIRE SENSOR CONNECTION
3W --> SELECT 3-WIRE SENSOR CONNECTION
4W --> SELECT 4-WIRE SENSOR CONNECTION

TC.TY
TC. B --> SELECT TC SENSOR TYPE
TC. E --> SELECT TC SENSOR TYPE
TC. J --> SELECT TC SENSOR TYPE
TC. K --> SELECT TC SENSOR TYPE
TC. L --> SELECT TC SENSOR TYPE
TC. N --> SELECT TC SENSOR TYPE
TC. R --> SELECT TC SENSOR TYPE
TC. S --> SELECT TC SENSOR TYPE
TC. T --> SELECT TC SENSOR TYPE
TC. U --> SELECT TC SENSOR TYPE
TC.W3 --> SELECT TC SENSOR TYPE
TC.W5 --> SELECT TC SENSOR TYPE
TC.LR --> SELECT TC SENSOR TYPE

DEC.P When temperature selected
 1111 --> DECIMAL POINT POSITION
 111.1 --> DECIMAL POINT POSITION

| | | | | | |
|-------------------------|-----|---------------------------------------|--|------------------|--|
| UNIT | | | | | |
| °C | --> | DISPLAY AND RELAY SETUP IN CELSIUS | | O.LO | |
| °F | --> | DISPLAY AND RELAY SETUP IN FAHRENHEIT | | xxxx | --> DISPLAY VALUE FOR OUTPUT LOW |
| REL1 | | | | O.HI | |
| SET | --> | ENTER RELAY 1 SETUP | | xxxx | --> DISPLAY VALUE FOR OUTPUT HIGH |
| SKIP | --> | SKIP RELAY 1 SETUP | | O.ERR | |
| OFF | --> | RELAY 1 DISABLED | | 23 mA | --> NAMUR NE43 UPSCALE AT ERROR |
| SETP | | | | 3,5 mA | --> NAMUR NE43 DOWNSCALE AT ERROR |
| xxxx | --> | RELAY SETPOINT | | 0mA | --> DOWNSCALE AT ERROR |
| ACT1 | | | | NONE | --> UNDEFINED OUTPUT AT ERROR |
| INCR | --> | ACTIVATE AT INCREASING SIGNAL | | RESP | |
| DECR | --> | ACTIVATE AT DECREASING SIGNAL | | xxx.x | --> ANALOG OUTPUT RESPONSE TIME IN SECONDS |
| HYS1 | | | | E.PAS | |
| xxxx | --> | RELAY HYSTERESIS | | NO | --> ENABLE PASSWORD PROTECTION |
| ERR1 | | | | YES | |
| HOLD | --> | HOLD RELAY AT ERROR | | N.PAS | |
| ACTI | --> | ACTIVATE RELAY AT ERROR | | xxxx | --> SELECT NEW PASSWORD |
| DEAC | --> | DEACTIVATE RELAY AT ERROR | | ADV MENU: | |
| NONE | --> | UNDEFINED STATUS AT ERROR | | LANG | --> ENTER LANGUAGE SETUP |
| ON.DE | | | | DISP | --> ENTER DISPLAY SETUP |
| xxxx | --> | RELAY ON-DELAY IN SECONDS | | CAL | --> PERFORM PROCESS CALIBRATION |
| OF.DE | | | | HLP.T | |
| xxxx | --> | RELAY OFF-DELAY IN SECONDS | | DE | --> DE - WAEHLE DEUTSCHEN HILFETEXT |
| RELX (X = 2...4) | | | | DK | --> DK - VAELG DANSK HJAELPETEKST |
| SET | --> | ENTER RELAY X SETUP | | ES | --> ES - SELECCIONAR TEXTO DE AYUDA EN ESPANOL |
| SKIP | --> | SKIP RELAY X SETUP | | FR | --> FR - SELECTION TEXTE D'AIDE EN FRANCAIS |
| OFF | --> | RELAY X DISABLED | | IT | --> IT - SELEZIONARE TESTI DI AIUTO ITALIANI |
| SETP | | | | SE | --> SE - VALJ SVENSK HJALPTTEXT |
| xxxx | --> | RELAY SETPOINT | | UK | --> UK - SELECT ENGLISH HELPTTEXT |
| ACTX (X = 2...4) | | | | CZ | --> CZ - VYBER CESKOU NAPOVEDU |
| INCR | --> | ACTIVATE AT INCREASING SIGNAL | | LIGH | |
| DECR | --> | ACTIVATE AT DECREASING SIGNAL | | xxxx | --> ADJUST DISPLAY LIGHT INTENSITY |
| HYSX (X = 2...4) | | | | CA.LO | |
| xxxx | --> | RELAY HYSTERESIS | | YES | --> CALIBRATE INPUT LOW TO PROCESS VALUE? |
| ERRX (X = 2...4) | | | | NO | |
| HOLD | --> | HOLD RELAY AT ERROR | | CA.HI | |
| ACTI | --> | ACTIVATE RELAY AT ERROR | | YES | --> CALIBRATE INPUT HIGH TO PROCESS VALUE? |
| DEAC | --> | DEACTIVATE RELAY AT ERROR | | NO | |
| NONE | --> | UNDEFINED STATUS AT ERROR | | VAL.L | |
| ON.DE | | | | xxxx | --> SET VALUE FOR LOW CALIBRATION POINT |
| xxxx | --> | RELAY ON-DELAY IN SECONDS | | VAL.H | |
| OF.DE | | | | xxxx | --> SET VALUE FOR HIGH CALIBRATION POINT |
| xxxx | --> | RELAY OFF-DELAY IN SECONDS | | USE.C | |
| A.OUT | | | | YES | --> USE PROCESS CALIBRATED VALUES? |
| 0-20 | --> | OUTPUT RANGE IN mA | | NO | |
| 4-20 | --> | OUTPUT RANGE IN mA | | | |
| 20-0 | --> | OUTPUT RANGE IN mA | | | |
| 20-4 | --> | OUTPUT RANGE IN mA | | | |

Configuration / operating the function keys

Documentation for routing diagram.

In general

When configuring the display you are guided through all parameters, you can choose the settings which fit the application. For each menu there is a scrolling help text which is automatically shown in the display, this starts after 5 seconds if no key has been activated.

Configuration is carried out by using the 3 function keys.

- ⏪ will increase the numerical value or choose the next parameter.
- ⏩ will decrease the numerical value or choose the previous parameter.
- ⏹ will accept the chosen value and end the menu.

If a function does not exist in the display all parameters are skipped to make the configuration as simple as possible. Once the configuration has been entered the display will show "----".

Pressing and holding ⏹ will return to the previous menu or return to the default state (1.0) without saving the changed values or parameters.

If no key is activated for 2 minutes, the display will return to the default state (1.0) without saving the changed values or parameters.

Further explanations

Fast setpoint adjustment and relay test: These menus allow you to change the set point quickly and to check the operation of the relays.

Pressing ⏪ and ⏩ at the same time will change the state of the relay - this change is indicated by the diodes on the display.

Pressing ⏹ will save the set point change.

Holding down ⏹ for more than 0.5 seconds will return the unit to the default state without changing the set point.

Password protection: Using a password will stop access to the menu and parameters. There are two levels of password protection. Passwords between 0000...4999 allow access to the fast set point adjustment and relay test. (Using this password stops access to all other parts of the menu). Passwords between 5000...9999 stop access to all parts of the menu, fast set point and relay test. (Current set point is still shown). If the configured password is not known, please contact PR electronics support - www.prelectronics.com/contact.

Programming via PC

By way of PReset, a simple yet sophisticated PC program, all operational parameters in the 5715 can be quickly configured to suit any application. Furthermore, the PC configuration allows you to set up a customer-defined input type for the input signals current, voltage, resistance and potentiometer. This input type can be defined with special input spans, e.g. 5...12 mA, and customer-defined linearisation with or without offset.

The customer-defined input type is saved in the 5715 in the input menu *CLIN*. If the display is later configured by way of the front keys for e.g. temperature input, the input type *CLIN* containing all the original parameters can be subsequently selected. The PC configuration is sent to the display by way of the communications interface USB Loop Link.

Graphic depiction of the relay function setpoint

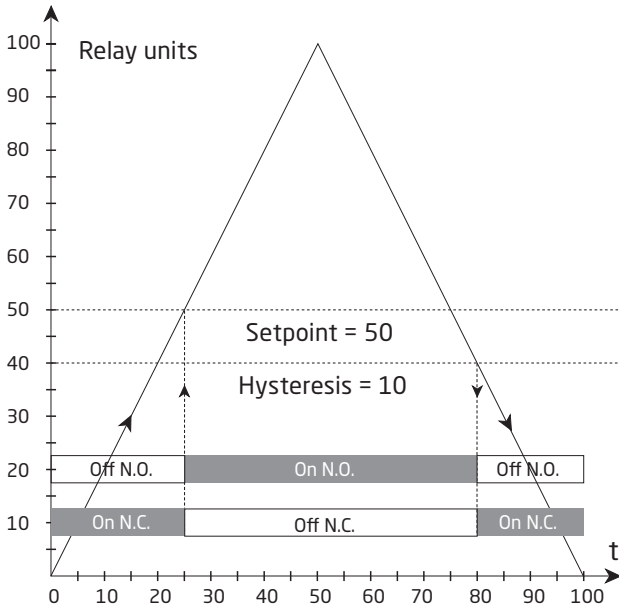

Relay action: Increasing

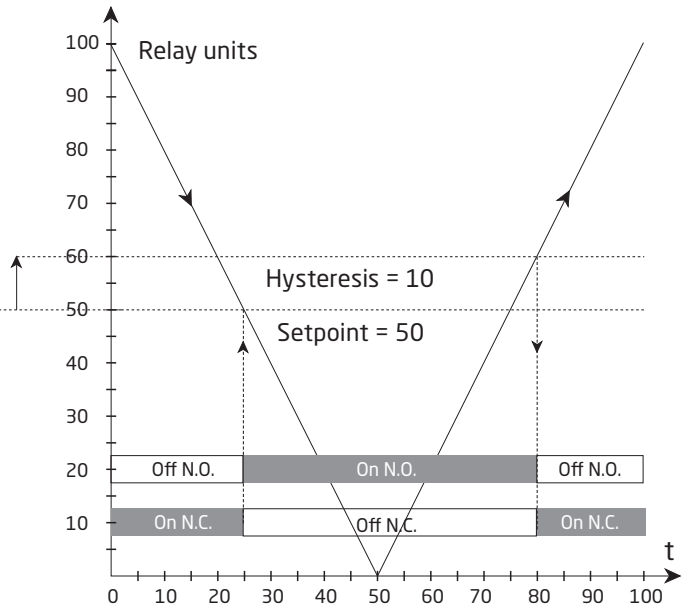

Relay action: Decreasing

Installation instructions

UL installation requirements

For use on a flat surface of a type 1 enclosure

Use 60/75°C copper conductors only

| | |
|---|-----------|
| Enclosure rating (face only) acc. to UL50E. | Type 4X |
| Max. ambient temperature | 60°C |
| Max. wire size, pins 41...46. | AWG 30-16 |
| Max. wire size, others | AWG 30-12 |
| UL file number | E248256 |

Relay outputs:

| | |
|----------------------------------|----------|
| Max. voltage | 250 VRMS |
| Max. current. | 2 A / AC |
| Max. AC power | 500 VA |
| Max. current at 24 VDC | 1 A |

Document history

The following list provides notes concerning revisions of this document.

| Rev. ID | Date | Notes |
|----------------|-------------|--|
| 103 | 2208 | Relay data updated, graph with resistive loads inserted. UKCA approval added. |
| 104 | 2230 | DNV marine approval replaced by EU-RO marine approval. |

We are near you, *all over the world*

Our trusted red boxes are supported wherever you are

All our devices are backed by expert service and a 5-year warranty. With each product you purchase, you receive personal technical support and guidance, day-to-day delivery, repair without charge within the warranty period and easily accessible documentation.

We are headquartered in Denmark, and have offices and authorized partners the world over. We are a local

business with a global reach. This means that we are always nearby and know your local markets well. We are committed to your satisfaction and provide PERFORMANCE MADE SMARTER all around the world.

For more information on our warranty program, or to meet with a sales representative in your region, visit prelectronics.com.

Benefit today from *PERFORMANCE MADE SMARTER*

PR electronics is the leading technology company specialized in making industrial process control safer, more reliable and more efficient. Since 1974, we have been dedicated to perfecting our core competence of innovating high precision technology with low power consumption. This dedication continues to set new standards for products communicating, monitoring and connecting our customers' process measurement points to their process control systems.

Our innovative, patented technologies are derived from our extensive R&D facilities and from having a great understanding of our customers' needs and processes. We are guided by principles of simplicity, focus, courage and excellence, enabling some of the world's greatest companies to achieve PERFORMANCE MADE SMARTER.