

PERFORMANCE
MADE
SMARTER

Product manual

6334

2-wire programmable transmitter

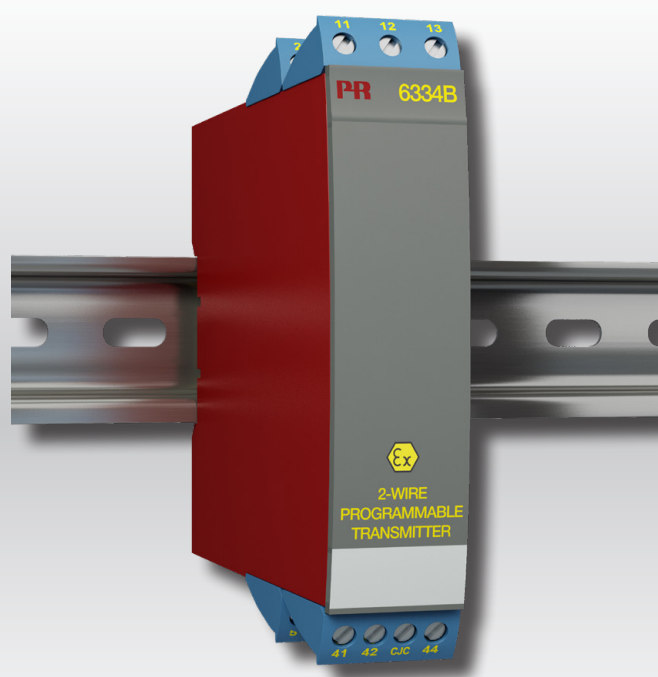

TEMPERATURE | I.S. INTERFACES | COMMUNICATION INTERFACES | MULTIFUNCTIONAL | ISOLATION | DISPLAY

No. 6334V108-UK
Serial no.: 221792263-241432015

PR
electronics

6 Product Pillars

to meet your every need

Individually outstanding, unrivalled in combination

With our innovative, patented technologies, we make signal conditioning smarter and simpler. Our portfolio is composed of six product areas, where we offer a wide range of analog and digital devices covering over a thousand applications in industrial and factory automation. All our products comply with or surpass the highest industry standards, ensuring reliability in even the harshest of environments and have a 5-year warranty for greater peace of mind.



Our range of temperature transmitters and sensors provides the highest level of signal integrity from the measurement point to your control system. You can convert industrial process temperature signals to analog, bus or digital communications using a highly reliable point-to-point solution with a fast response time, automatic self-calibration, sensor error detection, low drift, and top EMC performance in any environment.



We deliver the safest signals by validating our products against the toughest safety standards. Through our commitment to innovation, we have made pioneering achievements in developing I.S. interfaces with SIL 2 Full Assessment that are both efficient and cost-effective. Our comprehensive range of analog and digital intrinsically safe isolation barriers offers multifunctional inputs and outputs, making PR an easy-to-implement site standard. Our backplanes further simplify large installations and provide seamless integration to standard DCS systems.



We provide inexpensive, easy-to-use, future-ready communication interfaces that can access your PR installed base of products. All the interfaces are detachable, have a built-in display for readout of process values and diagnostics, and can be configured via push-buttons. Product specific functionality includes communication via Modbus and Bluetooth and remote access using our PR Process Supervisor (PPS) application, available for iOS and Android.



Our unique range of single devices covering multiple applications is easily deployable as your site standard. Having one variant that applies to a broad range of applications can reduce your installation time and training, and greatly simplify spare parts management at your facilities. Our devices are designed for long-term signal accuracy, low power consumption, immunity to electrical noise and simple programming.



Our compact, fast, high-quality 6 mm isolators are based on microprocessor technology to provide exceptional performance and EMC-immunity for dedicated applications at a very low total cost of ownership. They can be stacked both vertically and horizontally with no air gap separation between units required.



Our display range is characterized by its flexibility and stability. The devices meet nearly every demand for display readout of process signals and have universal input and power supply capabilities. They provide a real-time measurement of your process value no matter the industry and are engineered to provide a user-friendly and reliable relay of information, even in demanding environments.

2-wire programmable transmitter 6334

Table of contents

Application	4
Technical characteristics	4
Mounting / installation	4
Applications	4
Order	5
Electrical specifications	5
Connections	7
Block diagram	8
Programming	8
ATEX Installation Drawing - 6334A	9
ATEX Installation Drawing - 6334B	11
IECEX Installation Drawing - 6334A	13
IECEX Installation Drawing - 6334B	15
Document history	17

2-wire programmable transmitter 6334

- TC input
- High measurement accuracy
- Galvanic isolation
- Programmable sensor error value
- 1- or 2-channel version

Application

- Linearized temperature measurement with TC sensor.
- Amplification of bipolar mV signals to a 4...20 mA signal, optionally linearized according to a defined linearization function.

Technical characteristics

- Within a few seconds the user can program PR6334 to measure temperatures within all TC ranges defined by the norms.
- Cold junction compensation (CJC) with a mounted CJC connector.
- A limit can be programmed on the output signal.
- Continuous check of vital stored data for safety reasons.

Mounting / installation

- Mounted vertically or horizontally on a DIN rail. Using the 2-channel version up to 84 channels per metre can be mounted.
- The 6334A can be mounted in zone 2 and zone 22.
- The 6334B can be mounted in zone 0, 1, 2 and zone 21, 22 including M1.

Applications

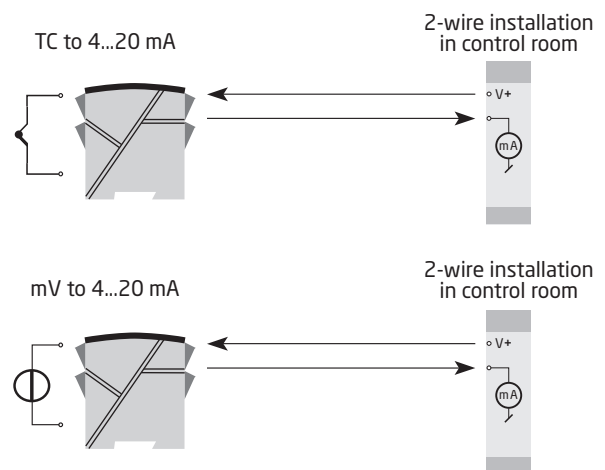

Order

Type	Version	Galvanic isolation	Channels
6334	Zone 2, 22 / Div. 2 : A	1500 VAC : 2	Single : A
	Zone 0, 1, 2, 21, 22, M1 / DIV. 1, DIV. 2 : B		Double : B

Electrical specifications

Environmental conditions:

Specification range	-40°C to +85°C
Storage temperature	-40°C to +85°C
Calibration temperature	20...28°
Humidity	< 95% RH (non-cond.)
Protection degree	IP20

Mechanical specifications:

Dimensions (H x W x D)	109 x 23.5 x 104 mm
Weight (1 / 2 channels)	145 / 185 g
DIN rail type	DIN EN/IEC 60715 - 35 mm
Wire size	0.13...2.08 mm ² / AWG 26...14 stranded wire
Screw terminal torque	0.5 Nm

Common specifications:

Supply voltage, DC	
6334A	7.2...35 VDC
6334B	7.2...30 VDC
Max. required power, 1 / 2 channels, 6334A	0.8 W / 1.6 W
Max. required power, 1 / 2 channels, 6334B	0.7 W / 1.4 W
Internal power dissipation, 6334A	0.17...0.8 W
Internal power dissipation, 6334B	0.17...0.7 W
Voltage drop	7.2 VDC
Isolation voltage, test / operation	1.5 kVAC / 50 VAC
Warm-up time	5 min.
Communications interface	Loop Link
Signal / noise ratio	Min. 60 dB
Response time (programmable)	1...60 s
EEPROM error check	< 3.5 s
Signal dynamics, input	18 bit
Signal dynamics, output	16 bit
Effect of supply voltage variation	< 0.005% of span / VDC

Accuracy, the greater of general and basic values:

General values		
Input type	Absolute accuracy	Temperature coefficient
All	$\leq \pm 0.05\%$ of span	$\leq \pm 0.01\%$ of span / °C

Basic values		
Input type	Basic accuracy	Temperature coefficient
Volt	$\leq \pm 10 \mu\text{V}$	$\leq \pm 1 \mu\text{V} / ^\circ\text{C}$
TC type: E, J, K, L, N, T, U	$\leq \pm 1^\circ\text{C}$	$\leq \pm 0.05^\circ\text{C} / ^\circ\text{C}$
TC type: B, R, S, W3, W5, LR	$\leq \pm 2^\circ\text{C}$	$\leq \pm 0.2^\circ\text{C} / ^\circ\text{C}$

EMC - immunity influence.	$< \pm 0.5\%$ of span
Extended EMC immunity: NAMUR NE 21, A criterion, burst	$< \pm 1\%$ of span

Electrical specifications, inputs:

Max. offset 50% of selec. max. value

TC inputs:

Type	Min. temperature	Max. temperature	Min. span	Standard
B	+400°C	+1820°C	100°C	IEC584
E	-100°C	+1000°C	50°C	IEC584
J	-100°C	+1200°C	50°C	IEC584
K	-180°C	+1372°C	50°C	IEC584
L	-100°C	+900°C	50°C	DIN 43710
N	-180°C	+1300°C	50°C	IEC584
R	-50°C	+1760°C	100°C	IEC584
S	-50°C	+1760°C	100°C	IEC584
T	-200°C	+400°C	50°C	IEC584
U	-200°C	+600°C	50°C	DIN 43710
W3	0°C	+2300°C	100°C	ASTM E988-90
W5	0°C	+2300°C	100°C	ASTM E988-90
LR	-200°C	+800°C	50°C	GOST 3044-84

Cold junction compensation $< \pm 1.0^\circ\text{C}$

Sensor error detection Yes

Sensor error current:

When detecting Nom. 33 μA

Else. 0 μA

Voltage inputs:

Measurement range -12...+150 mV

Min. span 5 mV

Input resistance 10 M Ω

Outputs:

Current outputs:

Signal range. 4...20 mA

Min. signal range.. 16 mA

Updating time 440 ms

Output signal at EEPROM error $\leq 3.5 \text{ mA}$

Load resistance. $\leq (V_{\text{supply}} - 7.2) / 0.023 [\Omega]$

Load stability $< \pm 0.01\%$ of span / 100 Ω

Sensor error detection:

Programmable	3.5...23 mA
NAMUR NE43 Upscale	23 mA
NAMUR NE43 Downscale.	3.5 mA

Of span = Of the presently selected range

Observed authority requirements:

EMC.	2014/30/EU & UK SI 2016/1091
ATEX	2014/34/EU & UK SI 2016/1107
RoHS	2011/65/EU & UK SI 2012/3032
EAC	TR-CU 020/2011
EAC Ex	TR-CU 012/2011

I.S. / Ex approvals:

6334A:	
ATEX	DEKRA 20ATEX0096 X
6334B:	
ATEX	DEKRA 20ATEX0095 X
6334A & 6334B:	
IECEX.	DEK 20.0059 X
EAC Ex.	RU C-DK.HA65.B.00355/19

Connections

Inputs:

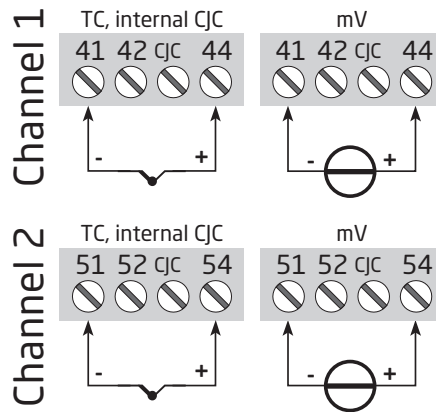

Outputs:

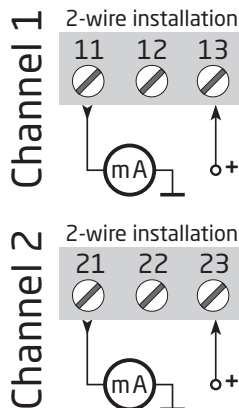

Block diagram

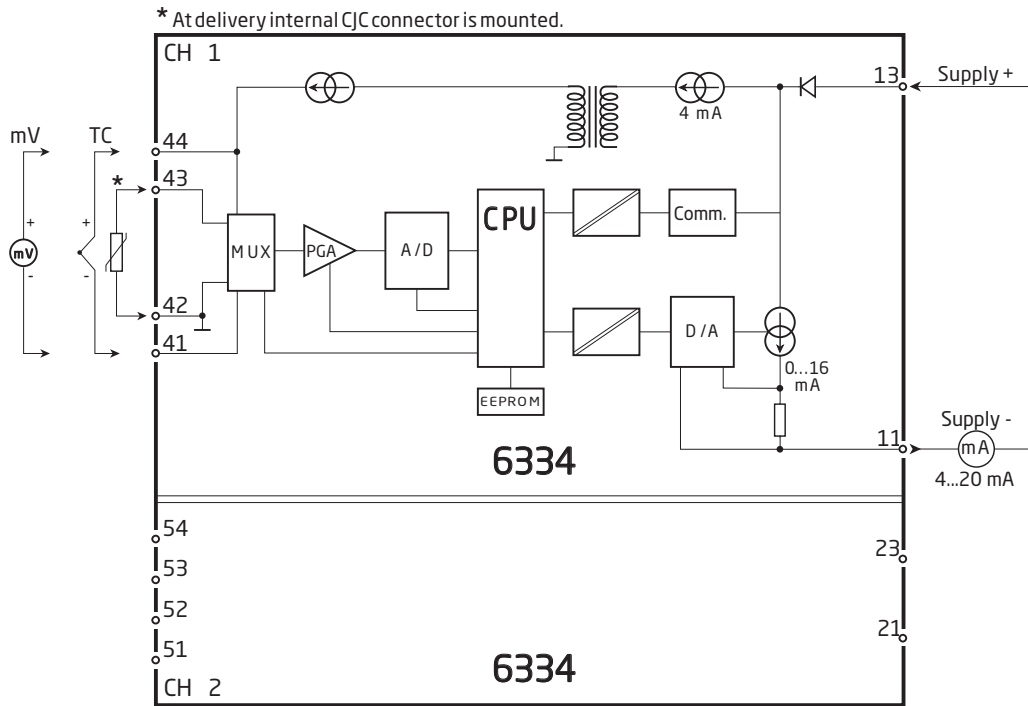

Programming

- Loop Link is a communications interface that is needed for programming 6334.
- For programming please refer to the drawing below and the help functions in PReset.
- When communicating with non-installed devices, connectors 11, 12, 13 (channel 1) and 21, 22, 23 (channel 2) can be dismantled in the safe area to connect the terminals of the communications interface to the pins.
- Loop Link is not approved for communication with devices installed in hazardous (Ex) areas.

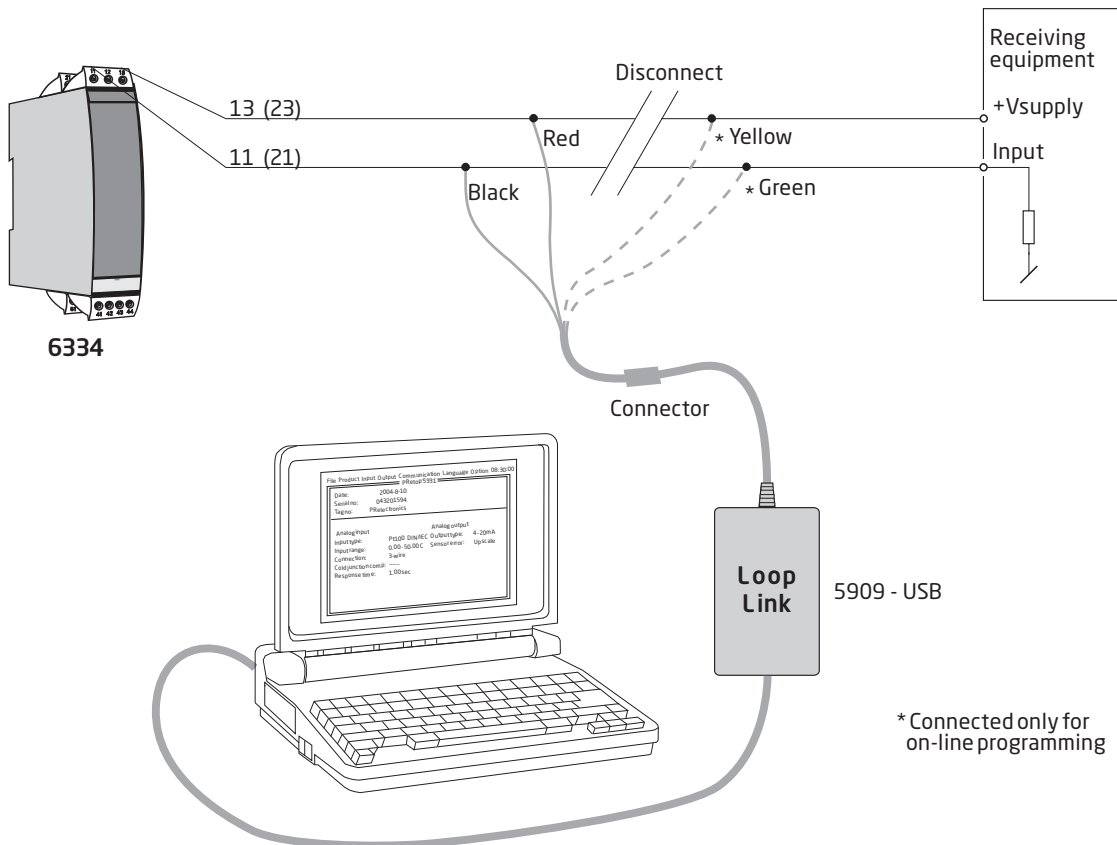

* Connected only for on-line programming

ATEX-installation drawing 6331QA02-V3R0

For safe installation of 6331A and 6334A the following must be observed. The module shall only be installed by qualified personnel who are familiar with the national and international laws, directives and standards that apply to this area. Year of manufacture can be taken from the first two digits in the serial number.

Certificate DEKRA 20ATEX 0096X

Marking  II 3 G Ex nA [ic] IIC T6 ... T4 Gc
 II 3 G Ex ec [ic] IIC T6 ... T4 Gc
 II 3 G Ex ic IIC T6 ... T4 Gc
 II 3 D Ex ic IIIC Dc

Standards EN 60079-0: 2018, EN 60079-11: 2012,
 EN 60079-15: 2010, EN 60079-7:2015+A1: 2018

Terminal 41,42,43,44 51,52,53,54	Terminal 11,12,13,14 21,22,23,24	Terminal 11,12,13,14 21,22,23,24	Terminal 11,12,13,14 21,22,23,24
Ex ic IIC, Ex ic IIIC	Ex ic IIC, Ex ic IIIC	Ex ic IIC, Ex ic IIIC	Ex nA, Ex ec
Uo: 9.6 V Io: 25 mA Po: 60 mW Lo: 33 mH Co: 2.4 µF	Ui = 35 V Ii = 110 mA Ci = 1 nF Li = 10 µH	Ui = 24 V Ii = 260 mA Ci = 1 nF Li = 10 µH	Umax ≤ 35 VDC or Umax ≤ 24 VDC

Ex ic IIC, Ex ic IIIC Temperature Class	Ambient temperature range	
	Ui=35 V	Ui=24 V
T6	-40°C to +54°C	-40°C to +63°C
T5	-40°C to +69°C	-40°C to +78°C
T4	-40°C to +85°C	-40°C to +85°C

Ex ec, Ex nA Temperature Class	Ambient temperature range	
	Vmax=35 V	Vmax=24 V
T6	-40°C to +43°C	-40°C to +55°C
T5	-40°C to +85°C	-40°C to +85°C
T4	-40°C to +85°C	-40°C to +85°C

Installation notes

If the enclosure is made of non-metallic plastic materials, electrostatic charges on the transmitter enclosure shall be avoided.

If the transmitter is installed in an explosive atmosphere requiring the use of equipment protection level Gc and applied in type of protection Ex ic, the transmitter shall be mounted in an enclosure that provides a degree of protection of at least IP20 according to EN 60529, and that is suitable for the application and correctly installed.

If the transmitter is installed in an explosive atmosphere requiring the use of equipment protection level Dc, the transmitter shall be mounted in a separately certified enclosure that provides a degree of protection of at least IP5X according to EN 60079-0, and that is suitable for the application and correctly installed. The surface temperature of the outer enclosure is +20 K above the ambient temperature, determined without a dust layer. Ambient temperature range: -40°C to +85°C.

If the transmitter is installed in an explosive atmosphere requiring the use of equipment protection level Gc and applied in type of protection Ex nA or Ex ec, the transmitter shall be mounted in a separately certified enclosure that provides a degree of protection of at least IP54 according to EN 60079-0, and that is suitable for the application and correctly installed.

If the transmitter is installed in an explosive atmosphere requiring the use of equipment protection level Gc and applied in type of protection Ex nA or Ex ec, the equipment shall only be used in an area of not more than pollution degree 2, as defined in EN 60664-1.

ATEX-installation drawing 6331QA01-V3R0



For safe installation of 6331Bxx or 6334Bxx the following must be observed. The module shall only be installed by qualified personnel who are familiar with the national and international laws, directives and standards that apply to this area. Year of manufacture can be taken from the first two digits in the serial number.

ATEX Certificate DEKRA 20ATEX 0095 X

Marking



II 1 G Ex ia IIC T6...T4 Ga
II 2 D Ex ia IIIC Db
I M1 Ex ia I Ma

Standards EN IEC 60079-0: 2018, EN 60079-11: 2012

Hazardous area
Zone 0, 1, 2, 21, 22

Non Hazardous Area

**Terminal:
41,42,43,44**
Uo: 9.6 VDC
Io: 25 mA
Po: 60 mW
Lo: 33 mH
Co: 2.4 μF

**Terminal:
51,52,53,54**
Uo: 9.6 VDC
Io: 25 mA
Po: 60 mW
Lo: 33 mH
Co: 2.4 μF

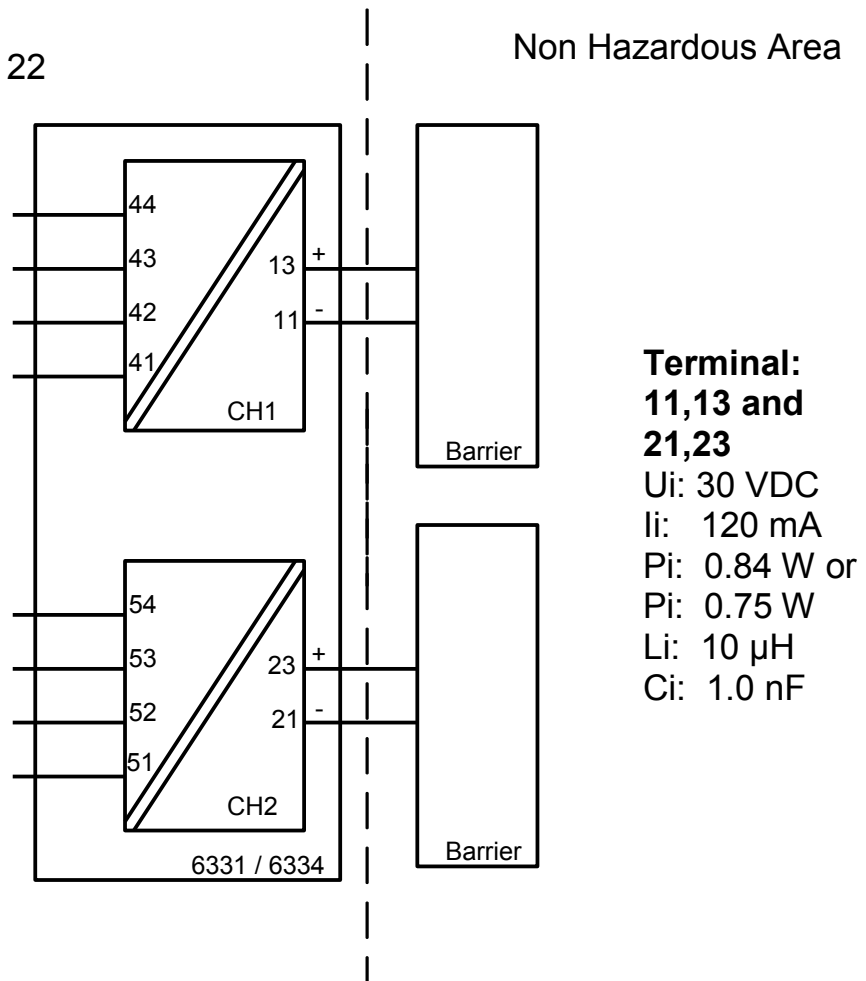

**Terminal:
11,13 and
21,23**
Ui: 30 VDC
Ii: 120 mA
Pi: 0.84 W or
Pi: 0.75 W
Li: 10 μH
Ci: 1.0 nF

Temperature Class	Ambient temperature range	
	Pi: 0.84 W	Pi: 0.75 W
T6	-40°C to +40°C	-40°C to +45°C
T5	-40°C to +55°C	-40°C to +60°C
T4	-40°C to +85°C	-40°C to +85°C

Installation notes

If the enclosure is made of non-metallic plastic materials, electrostatic charges on the transmitter enclosure shall be avoided.

If the transmitter is installed in an explosive atmosphere requiring the use of equipment protection level Ga, the transmitter shall be mounted in an enclosure that provides a degree of protection of at least IP20 according to EN 60529, and that is suitable for the application and correctly installed.

If the transmitter is installed in an explosive atmosphere requiring the use of equipment protection level Ga or Ma, and if the enclosure is made of aluminum, it must be installed such, that ignition sources due to impact and friction sparks are excluded.

If the transmitter is installed in an explosive atmosphere requiring the use of equipment protection level Db, the transmitter shall be mounted in a separately certified enclosure that provides a degree of protection of at least IP5X according to EN 60079-0, and that is suitable for the application and correctly installed.

If the transmitter is installed in an explosive atmosphere requiring the use of equipment protection level Ma, the transmitter shall be mounted in an enclosure that provides a degree of protection of at least IP54 according to EN 60529, and that is suitable for the application and correctly installed.

Cable entries and blanking elements shall be used that are suitable for the application and correctly installed.

For an ambient temperature $\geq 60^\circ\text{C}$, heat resistant cables shall be used with a rating of at least 20 K above the ambient temperature.

The sensor circuit is not infallibly galvanically isolated from the input circuit. However, the galvanic isolation between the circuits is capable of withstanding a test voltage of 500 VAC for 1 minute.

IECEx-installation drawing 6331QI02-V3R0

For safe installation of 6331A and 6334A the following must be observed. The module shall only be installed by qualified personnel who are familiar with the national and international laws, directives and standards that apply to this area. Year of manufacture can be taken from the first two digits in the serial number.

Certificate IECEx DEK 20.0059X

Marking Ex nA [ic] IIC T6 ... T4 Gc
Ex ec [ic] IIC T6 ... T4 Gc
Ex ic IIC T6 ... T4 Gc
Ex ic IIIC Dc

Standards IEC 60079-0: 2017, IEC 60079-11: 2011,
IEC 60079-15: 2010, IEC 60079-7: 2017

Terminal 41,42,43,44 51,52,53,54	Terminal 11,12,13,14 21,22,23,24	Terminal 11,12,13,14 21,22,23,24	Terminal 11,12,13,14 21,22,23,24
Ex ic IIC, Ex ic IIIC	Ex ic IIC, Ex ic IIIC	Ex ic IIC, Ex ic IIIC	Ex nA, Ex ec
Uo: 9.6 V Io: 25 mA Po: 60 mW Lo: 33 mH Co: 2.4 µF	Ui = 35 V Ii = 110 mA Ci = 1 nF Li = 10 µH	Ui = 24 V Ii = 260 mA Ci = 1 nF Li = 10 µH	Umax ≤ 35 VDC or Umax ≤ 24 VDC

Ex ic IIC, Ex ic IIIC Temperature Class	Ambient temperature range	
	Ui=35 V	Ui=24 V
T6	-40°C to +54°C	-40°C to +63°C
T5	-40°C to +69°C	-40°C to +78°C
T4	-40°C to +85°C	-40°C to +85°C

Ex ec, Ex nA Temperature Class	Ambient temperature range	
	Vmax=35 V	Vmax=24 V
T6	-40°C to +43°C	-40°C to +55°C
T5	-40°C to +85°C	-40°C to +85°C
T4	-40°C to +85°C	-40°C to +85°C

Installation notes

If the enclosure is made of non-metallic plastic materials, electrostatic charges on the transmitter enclosure shall be avoided.

If the transmitter is installed in an explosive atmosphere requiring the use of equipment protection level Gc and applied in type of protection Ex ic, the transmitter shall be mounted in an enclosure that provides a degree of protection of at least IP20 according to IEC 60529, and that is suitable for the application and correctly installed.

If the transmitter is installed in an explosive atmosphere requiring the use of equipment protection level Dc, the transmitter shall be mounted in a separately certified enclosure that provides a degree of protection of at least IP5X according to IEC 60079-0, and that is suitable for the application and correctly installed. The surface temperature of the outer enclosure is +20 K above the ambient temperature, determined without a dust layer. Ambient temperature range: -40°C to +85°C.

If the transmitter is installed in an explosive atmosphere requiring the use of equipment protection level Gc and applied in type of protection Ex nA or Ex ec, the transmitter shall be mounted in a separately certified enclosure that provides a degree of protection of at least IP54 according to IEC 60079-0, and that is suitable for the application and correctly installed.

If the transmitter is installed in an explosive atmosphere requiring the use of equipment protection level Gc and applied in type of protection Ex nA or Ex ec, the equipment shall only be used in an area of not more than pollution degree 2, as defined in IEC 60664-1.

IECEX-installation drawing 6331QI01-V2R0



For safe installation of 6331Bxx or 6334Bxx the following must be observed. The module shall only be installed by qualified personnel who are familiar with the national and international laws, directives and standards that apply to this area. Year of manufacture can be taken from the first two digits in the serial number.

Certificate IECEx DEK 20.0059X

Marking Ex ia IIC T6...T4 Ga
 Ex ia IIIC Db
 Ex ia I Ma

Standards IEC 60079-0: 2017, IEC 60079-11: 2011

Hazardous area
 Zone 0, 1, 2, 21, 22

Non Hazardous Area

**Terminal:
 41,42,43,44**
 Uo: 9.6 VDC
 Io: 25 mA
 Po: 60 mW
 Lo: 33 mH
 Co: 2.4 µF

**Terminal:
 51,52,53,54**
 Uo: 9.6 VDC
 Io: 25 mA
 Po: 60 mW
 Lo: 33 mH
 Co: 2.4 µF

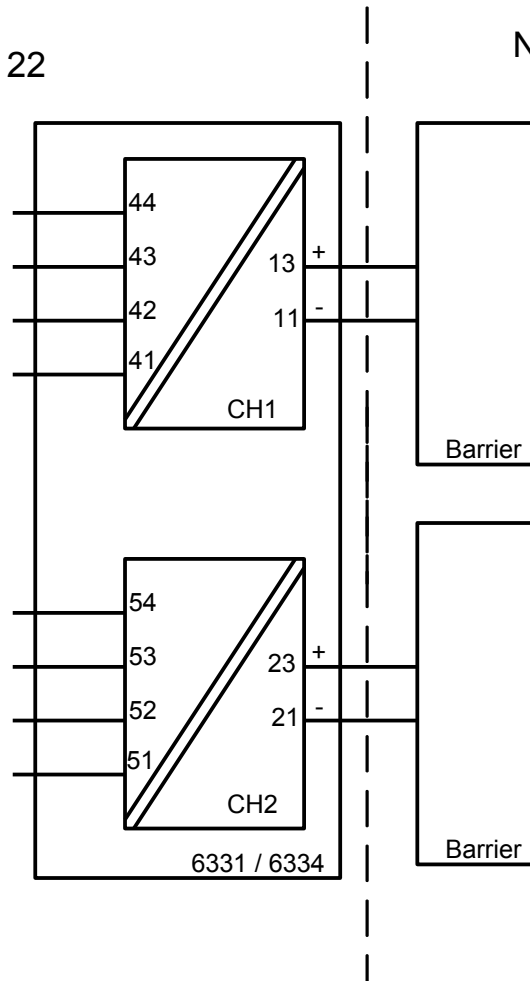

**Terminal:
 11,13 and
 21,23**
 Ui: 30 VDC
 Ii: 120 mA
 Pi: 0.84 W or
 Pi: 0.75 W
 Li: 10 µH
 Ci: 1.0 nF

Temperature Class	Ambient temperature range	
	Pi: 0.84 W	Pi: 0.75 W
T6	-40°C to +40°C	-40°C to +45°C
T5	-40°C to +55°C	-40°C to +60°C
T4	-40°C to +85°C	-40°C to +85°C

Installation notes

If the enclosure is made of non-metallic plastic materials, electrostatic charges on the transmitter enclosure shall be avoided.

If the transmitter is installed in an explosive atmosphere requiring the use of equipment protection level Ga, the transmitter shall be mounted in an enclosure that provides a degree of protection of at least IP20 according to IEC 60529, and that is suitable for the application and correctly installed.

If the transmitter is installed in an explosive atmosphere requiring the use of equipment protection level Ga or Ma, and if the enclosure is made of aluminum, it must be installed such, that ignition sources due to impact and friction sparks are excluded.

If the transmitter is installed in an explosive atmosphere requiring the use of equipment protection level Db, the transmitter shall be mounted in a separately certified enclosure that provides a degree of protection of at least IP5X according to IEC 60079-0, and that is suitable for the application and correctly installed. The surface temperature of the outer enclosure is +20 K above the ambient temperature, determined without a dust layer.
Ambient temperature range: -40°C to +85°C.

If the transmitter is installed in an explosive atmosphere requiring the use of equipment protection level Ma, the transmitter shall be mounted in an enclosure that provides a degree of protection of at least IP54 according to IEC 60529, and that is suitable for the application and correctly installed.
Ambient temperature range: -40°C to +85°C.

Cable entries and blanking elements shall be used that are suitable for the application and correctly installed.

For an ambient temperature $\geq 60^\circ\text{C}$, heat resistant cables shall be used with a rating of at least 20 K above the ambient temperature.

The sensor circuit is not infallibly galvanically isolated from the input circuit. However, the galvanic isolation between the circuits is capable of withstanding a test voltage of 500 VAC for 1 minute.

Document history

The following list provides notes concerning revisions of this document.

Rev. ID	Date	Notes
106	1548	IECEX approval added.
107	2242	ATEX and IECEX approvals updated - Ex na changed to Ex ec.
108	2311	UKCA added.

We are near you, *all over the world*

Our trusted red boxes are supported wherever you are

All our devices are backed by expert service and a 5-year warranty. With each product you purchase, you receive personal technical support and guidance, day-to-day delivery, repair without charge within the warranty period and easily accessible documentation.

We are headquartered in Denmark, and have offices and authorized partners the world over. We are a local business

with a global reach. This means that we are always nearby and know your local markets well.

We are committed to your satisfaction and provide PERFORMANCE MADE SMARTER all around the world.

For more information on our warranty program, or to meet with a sales representative in your region, visit prelectronics.com.

Benefit today from *PERFORMANCE MADE SMARTER*

PR electronics is the leading technology company specialized in making industrial process control safer, more reliable and more efficient. Since 1974, we have been dedicated to perfecting our core competence of innovating high precision technology with low power consumption. This dedication continues to set new standards for products communicating, monitoring and connecting our customers' process measurement points to their process control systems.

Our innovative, patented technologies are derived from our extensive R&D facilities and from having a great understanding of our customers' needs and processes. We are guided by principles of simplicity, focus, courage and excellence, enabling some of the world's greatest companies to achieve PERFORMANCE MADE SMARTER.