

DK ADVARSEL

Reparation af modulet må kun foretages af PR electronics A/S.

ADVARSEL

PR Loop Link programmeringsenheden må ikke benyttes til kommunikation med moduler installeret i Ex-område. Enhederne skal installeres i henhold til den tilhørende installations vejledning ved montering i eksplosionsfarlig område.

SIKKERHEDSREGLER

Modtagelse og udpakning
Udpak modulet uden at beskadige det. Kontrollér ved modtagelsen, at modulytten svarer til den bestilte. Indpakningen bør følge modulet, indtil dette er monteret på bilvende plads.

Miljøforhold
Undgå direkte sollys, kraftigt støv eller varme, mekaniske rystelser og stød, og udsæt ikke modulet for regn eller kraftigt fugt. Om nødvendigt skal opvarmning, ud over de opgivne grænser for omgivelsestemperatur, forhindres ved hjælp af ventilation.

Installation
Modulet må kun tilsluttes af kvalificerede teknikere, som er bekendt med de tekniske udtryk, advarsler og instruktioner i installationsvejledningen, og som vil følge disse. Hvis der er tvivl om modulets rette håndtering, skal der rettes henvendelse til den lokale forhandler eller alternativt direkte til PR electronics A/S.
Mounting and connection of the device should comply with national legislation for mounting of electric materials, i.e. wire cross section, protective fuse, and location. Descriptions of input / output and supply connections are shown in the product manual found on www.prellectronics.com.

Kalibrering og justering
Under kalibrering og justering skal måling og tilslutning af eksterne spændinger udføres i henhold til denne installations-vejledning, og teknikeren skal benytte sikkerhedsmæssigt korrekte værktøjer og instrumenter.

Renngøring
Modulet må, i spændingsløs tilstand, rengøres med en klud let fugtet med destilleret vand.

PC-programmering af SYSTEM 5300
Modulet konfigureres til den aktuelle opgave ved hjælp af en PC og PR electronics A/S' kommunikationsinterface Loop Link. Det er muligt at konfigurere modulet både med og uden tilsluttet forsyningspænding, idet kommunikationsinterface leverer nødvendig forsyning til opsætningen. Kommunikationsinterface er galvanisk isoleret, så PC'ens port er optimalt beskyttet. Kommunikationen er 2-vejs, så modulets opsætning kan hentes ind i PC'en, og opsætningen i PC'en kan sendes til modulet. For at brugere, der ikke selv vil foretage opsætning, kan modulet leveres konfigureret efter oplyst specifikation: indgangstype, måleområde, følerfejdetektering og udgangssignal.

Elektriske specifikationer

| | |
|--|-----------------------|
| Specifikationsområde..... | -40°C til +85°C |
| Forsyningsspænding, 5333A & 5343A..... | 8.0..35 VDC |
| Internt effekttab, 5333A & 5343A..... | 25 mW..0.8 W |
| Forsyningsspænding, 5333D & 5343B..... | 8.0..30 VDC |
| Internt effekttab, 5333D & 5343B..... | 25 mW..0.7 W |
| Kalibreringstemperatur..... | 20..28°C |
| Relativ fugtighed..... | < 95% RH (ikke kond.) |
| Mål..... | Ø44 x 20,2 mm |
| Kapslingsklasse (hus/klemme)..... | IP68 / IP00 |

Indgangstyper:

| | |
|-------------------|----------------|
| *P1100..... | -200°C..+850°C |
| *N1100..... | -60°C..+250°C |
| Lin. R, 5333..... | 0 Ω..10000 Ω |
| Lin. R, 5343..... | 0 Ω..100 kΩ |

Strømodgang:

| | |
|-----------------------------|--------------------------|
| Signalområde..... | 4..20 mA |
| Min. signalområde..... | 15 mA |
| Belastningsmodstand, Ω..... | ≤ (Vforsyn.-8.0 V)/0,023 |

Overholdte myndighedskrav:

| | |
|-------------|----------------|
| EMC..... | 2014/30/EU |
| ATEX..... | 2014/34/EU |
| RoHS..... | 2011/65/EU |
| EAC..... | TR-CU 020/2011 |
| EAC Ex..... | TR-CU 012/2011 |

Godkendelser:

| | |
|----------------------------|------------|
| DNV, Ships & Offshore..... | TAA0000101 |
|----------------------------|------------|

* Gælder kun 5333

UK WARNING

Repair of the device must be done by PR electronics A/S only.

WARNING

Do not use the Loop Link programming interface to program the units in Ex area. For installation in classified area the modules must be installed according to the appropriate installation drawings.

SAFETY INSTRUCTIONS

Receipt and unpacking
Unpack the device without damaging it. The packing should always follow the device until this has been permanently mounted. Check at the receipt of the device whether the type corresponds to the one ordered.

Environment
Avoid direct sunlight, dust, high temperatures, mechanical vibrations and shock, as well as rain and heavy moisture. If necessary, heating in excess of the stated limits for ambient temperatures should be avoided by way of ventilation.

Mounting
Only qualified technicians who are familiar with the technical terms, warnings, and instructions in this installation guide and who are able to follow these should connect the device. Should there be any doubt as to the correct handling of the device, please contact your local distributor or, alternatively, PR electronics A/S.
Mounting and connection of the device should comply with national legislation for mounting of electric materials, i.e. wire cross section, protective fuse, and location. Descriptions of input / output and supply connections are shown in the product manual found on www.prellectronics.com.

Calibration and adjustment
During calibration and adjustment, the measuring and connection of external voltages must be carried out according to the specifications of this installation guide. The technician must use tools and instruments that are safe to use.

Cleaning
When disconnected, the device may be cleaned with a cloth moistened with distilled water.

PC programming of SYSTEM 5300
The device is configured to the present task by way of a PC and PR electronics A/S' communications interface Loop Link. The device can be configured with or without a connected supply voltage as the communications interface supplies the necessary voltage to the set-up. The communications interface is galvanically isolated to protect the PC port.
Communication is 2-way to allow the retrieval of the device set-up into the PC and to allow the transmission of the PC set-up to the device. For users who do not wish to do the set-up themselves, the device can be delivered configured according to customer specifications: input type, measurement range, sensor error detection, and output signal.

Electrical specifications

| | |
|--|----------------------|
| Specifications range..... | -40°C to +85°C |
| Supply voltage, 5333A & 5343A..... | 8.0..35 VDC |
| Internal power dissipation, 5333A & 5343A..... | 25 mW..0.8 W |
| Supply voltage, 5333D & 5343B..... | 8.0..30 VDC |
| Internal power dissipation, 5333D & 5343B..... | 25 mW..0.7 W |
| Calibration temperature..... | 20..28°C |
| Relative humidity..... | < 95% RH (non-cond.) |
| Dimensions..... | Ø44 x 20.2 mm |
| Protection degree (enc./terminal)..... | IP68 / IP00 |

Input types:

| | |
|-------------------|----------------|
| *P1100..... | -200°C..+850°C |
| *N1100..... | -60°C..+250°C |
| Lin. R, 5333..... | 0 Ω..10000 Ω |
| Lin. R, 5343..... | 0 Ω..100 kΩ |

Current output:

| | |
|-------------------------|-------------------------|
| Signal range..... | 4..20 mA |
| Min. signal range..... | 15 mA |
| Load resistance, Ω..... | ≤ (Vsupply-8.0 V)/0,023 |

Observed authority requirements:

| | |
|-------------|----------------|
| EMC..... | 2014/30/EU |
| ATEX..... | 2014/34/EU |
| RoHS..... | 2011/65/EU |
| EAC..... | TR-CU 020/2011 |
| EAC Ex..... | TR-CU 012/2011 |

Approvals:

| | |
|----------------------------|------------|
| DNV, Ships & Offshore..... | TAA0000101 |
|----------------------------|------------|

* Only applies to 5333

FR AVERTISSEMENT

Seule PR electronics SARL est autorisée à réparer le module.

AVERTISSEMENT

Ne pas utiliser le kit de programmation "Loop Link" en zone classée dangereuse Ex. Pour des installations en zone classée, les modules doivent être monté conformément aux plans appropriés.

CONSIGNES DE SECURITE

Réception et déballage
Déballé le module sans l'endommager. Il est recommandé de conserver l'emballage du module tant que ce dernier n'est pas définitivement monté. A la réception du module, vérifiez que le type de module reçu correspond à celui que vous avez commandé.

Environment
N'exposez pas votre module aux rayons directs du soleil et choisissez un endroit à humidité modérée et à l'abri de la poussière, des températures élevées, des chocs et des vibrations mécaniques et de la pluie. Le cas échéant, des systèmes de ventilation permettent d'éviter qu'une pièce soit chauffée au-delà des limites prescrites pour les températures ambiantes.

Montage
Il est conseillé de réserver le raccordement du module aux techniciens qualifiés qui connaissent les termes techniques, les avertissements et les instructions de ce guide et qui sont capables d'appliquer ces dernières.
Si vous avez un doute quelconque quant à la manipulation du module, veuillez contacter votre distributeur local. Vous pouvez également vous adresser à PR electronics SARL.
Le montage et le raccordement du module doivent être conformes à la législation nationale en vigueur pour le montage de matériels électriques, par exemple, par section des fils, fusibles de protection et implantation des modules. Les connexions des alimentations et des entrées / sorties sont décrites dans le manuel du produit sur www.prellectronics.fr.

Etalonnage et réglage
Lors des opérations d'étalonnage et de réglage, il convient d'effectuer les mesures et les connexions des tensions externes en respectant les spécifications mentionnées dans ce guide. Les techniciens doivent utiliser des outils et des instruments pouvant être manipulés en toute sécurité.

Maintenance et entretien
Une fois le module hors tension, prenez un chiffon imbibé d'eau distillée pour le nettoyer.

Programmation par PC du SYSTEME 5300
Le module peut être programmé en fonction d'une application donnée à partir d'un PC et le kit de programmation Loop Link de PR electronics A/S. Le module peut être programmé sans être alimenté car l'interface de communication fournit l'alimentation nécessaire pour la configuration. L'interface de communication est dotée d'une isolation galvanique qui protège le port du PC. La communication est bidirectionnelle. Cela permet non seulement la programmation du module mais également la récupération d'une configuration existante ainsi que la lecture du numéro de série et du repère. Le module peut être livré déjà programmé, si l'utilisateur le souhaite.

Spécifications

| | |
|--|-----------------------|
| Plage de température..... | -40°C à +85°C |
| Tension d'alimentation, 5333A & 5343A..... | 8.0..35 Vcc |
| Puissance dissipée, 5333A & 5343A..... | 25 mW..0.8 W |
| Tension d'alimentation, 5333D & 5343B..... | 8.0..30 Vcc |
| Puissance dissipée, 5333D & 5343B..... | 25 mW..0.7 W |
| Température d'étalonnage..... | 20..28°C |
| Humidité relative..... | < 95% HR (sans cond.) |
| Dimensions..... | Ø44 x 20,2 mm |
| Degré de protection (boîtier/boîtier)..... | IP68 / IP00 |

Types d'entrée:

| | |
|-------------------|----------------|
| *P1100..... | -200°C..+850°C |
| *N1100..... | -60°C..+250°C |
| Lin. R, 5333..... | 0 Ω..10000 Ω |
| Lin. R, 5343..... | 0 Ω..100 kΩ |

Sortie courant:

| | |
|------------------------------|-------------------------|
| Gamme de signal..... | 4..20 mA |
| Plage de signal min..... | 15 mA |
| Résistance de charge, Ω..... | ≤ (Vvalim.-8.0 V)/0,023 |

Compatibilité avec les normes:

| | |
|-------------|----------------|
| CEM..... | 2014/30/UE |
| ATEX..... | 2014/34/UE |
| RoHS..... | 2011/65/UE |
| EAC..... | TR-CU 020/2011 |
| EAC Ex..... | TR-CU 012/2011 |

Approbations:

| | |
|----------------------------|------------|
| DNV, Ships & Offshore..... | TAA0000101 |
|----------------------------|------------|

* Uniquement applicable pour 5333

DE WARNUNG

Reparaturen des Gerätes dürfen nur von PR electronics A/S vorgenommen werden.

WARNUNG

Benutzen Sie die Programmierschnittstelle Loop Link nicht im Ex-Bereich. Zur Montage in klassifizierten Zonen müssen die Geräte nach den dazugehörigen Einbauzeichnungen installiert werden.

SICHERHEITSGEDELN

Empfang und Auspacken
Packen Sie das Gerät aus, ohne es zu beschädigen, und kontrollieren Sie beim Empfang, ob der Gerätetyp Ihrer Bestellung entspricht. Die Verpackung sollte beim Gerät bleiben, bis dieses am endgültigen Platz montiert ist.

Umgebungsbedingungen
Direkte Sonneneinstrahlung, starke Staubbildung oder Hitze, mechanische Erschütterungen und Stöße sind zu vermeiden; das Gerät darf nicht Regen oder starker Feuchtigkeit ausgesetzt werden. Bei Bedarf muss eine Erwärmung, welche die angegebenen Grenzen für die Umgebungstemperatur überschreitet, mit Hilfe eines Kühlgebläses verhindert werden.

Installation
Das Gerät darf nur von qualifizierten Technikern angeschlossen werden, die mit den technischen Ausdrücken, Warnungen und Anweisungen in dieser Installationsanleitung vertraut sind und diese befolgen.
Sollten Zweifel bezüglich der richtigen Handhabung des Gerätes bestehen, sollte man mit dem Händler vor Ort Kontakt aufnehmen. Sie können aber auch direkt mit PR electronics GmbH Kontakt aufnehmen.
Die Installation und der Anschluss des Gerätes haben in Übereinstimmung mit den geltenden Regeln des jeweiligen Landes bez. der Installation elektrischer Apparaturen zu erfolgen, u.a. bezüglich Leitungsquerschnitt, (elektrischer) Vorabsicherung und Positionierung.
Eine Beschreibung von Eingangs- / Ausgangs- und Versorgungsanschlüssen befindet sich im Produkthandbuch, das unter www.prellectronics.de gefunden und abgerufen kann.

Kalibrierung und Justierung
Während der Kalibrierung und Justierung sind die Messung und der Anschluss externer Spannungen entsprechend dieser Installationsanleitung auszuführen, und der Techniker muss hierbei sicherheitsmäßig einwandfreie Werkzeuge und Instrumente benutzen.

Reinigung
Das Gerät darf in spannungslosem Zustand mit einem Lappen gereinigt werden, der mit destilliertem Wasser leicht angefeuchtet ist.

PC-Programmierung des Systems 5300
Das Gerät wird für die jeweilige Aufgabe mit Hilfe eines PCs und PR electronics A/S Kommunikationschnittstelle Loop Link konfiguriert. Es ist möglich, das Gerät sowohl mit als auch ohne angeschlossene Versorgungsspannung zu konfigurieren, da die Kommunikationschnittstelle die notwendige Versorgung für die Einstellung liefert. Die Kommunikationschnittstelle ist galvanisch isoliert, sodass der Anschluss des PCs optimal geschützt ist.
Die Kommunikation erfolgt in beiden Richtungen, sodass die Einstellung des Gerätes in den PC geholt, und die Einstellung im PC an das Gerät gesandt werden kann. Für diejenigen Anwender, welche die Einstellung nicht selbst vornehmen wollen, kann das Gerät nach folgenden Kundenspezifikationen konfiguriert geliefert werden: Eingangstyp, Messbereich, Fehlererkennung und Ausgangssignal.

Elektrische Daten

| | |
|---|------------------------|
| Spezifikationsbereich..... | -40°C bis +85°C |
| Versorgungsspannung, 5333A & 5343A..... | 8.0..35 VDC |
| Verlustleistung, 5333A & 5343A..... | 25 mW..0.8 W |
| Versorgungsspannung, 5333D & 5343B..... | 8.0..30 VDC |
| Verlustleistung, 5333D & 5343B..... | 25 mW..0.7 W |
| Kalibreringstemperatur..... | 20..28°C |
| Luftfeuchtigkeit..... | < 95% RF (nicht kond.) |
| Maß..... | Ø44 x 20,2 mm |
| Schutzart (Gehäuse / Anschluss)..... | IP68 / IP00 |

Eingangs-Typen:

| | |
|-------------------|----------------|
| *P1100..... | -200°C..+850°C |
| *N1100..... | -60°C..+250°C |
| Lin. R, 5333..... | 0 Ω..10000 Ω |
| Lin. R, 5343..... | 0 Ω..100 kΩ |

Stromausgang:

| | |
|------------------------------|--------------------------|
| Signalbereich..... | 4..20 mA |
| Min. Signalbereich..... | 15 mA |
| Belastungswiderstand, Ω..... | ≤ (Vversor.-8.0 V)/0,023 |

Eingehaltene Behördenvorschriften:

| | |
|-------------|------------------------------|
| EMV..... | 2014/30/UE & UK SI 2016/1091 |
| ATEX..... | 2014/34/UE & UK SI 2016/1107 |
| RoHS..... | 2011/65/UE & UK SI 2012/3032 |
| EAC..... | TR-CU 020/2011 |
| EAC Ex..... | TR-CU 012/2011 |

Zulassungen:

| | |
|----------------------------|------------|
| DNV, Ships & Offshore..... | TAA0000101 |
|----------------------------|------------|

* Gilt nur für 5333

5333A, 5333D, 5343A & 5343B

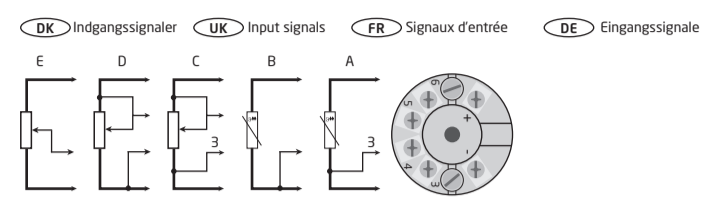

| | DK | UK | FR | DE | 5333 | 5343 |
|---|------------------------|-----------------------|-----------------------|-------------------------|------|------|
| A | RTD, 3-leder | RTD, 3-wire | RTD, 3-fils | WTH, 3-Letter | x | |
| B | RTD, 2-leder | RTD, 2-wire | RTD, 2-fils | WTH, 2-Letter | x | |
| C | Modstand, 3-leder | Resistance, 3-wire | Résistance, 3-fils | Widerstand, 3-Letter | x | x |
| D | Modstand, 2-leder | Resistance, 2-wire | Résistance, 2-fils | Widerstand, 2-Letter | x | x |
| E | Potentiometer, 3-leder | Potentiometer, 3-wire | Potentiomètre, 3-fils | Potentiometer, 3-Letter | | x |

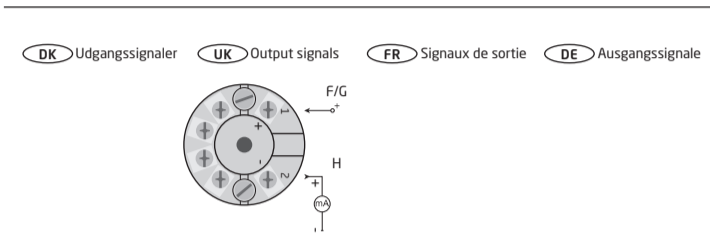

| | DK | UK | FR | DE | 5333A | 5333D | 5343A | 5343B |
|---|------------------------|---------------------|---------------------------|-------------------------|-------|-------|-------|-------|
| F | Forsyning +8.0..35 VDC | Supply +8.0..35 VDC | Alimentation +8.0..35 Vcc | Versorgung +8.0..35 VDC | x | | x | |
| G | Forsyning +8.0..30 VDC | Supply +8.0..30 VDC | Alimentation +8.0..30 Vcc | Versorgung +8.0..30 VDC | | x | | x |
| H | 4..20 mA udgang | 4..20 mA output | Sortie 4..20 mA | 4..20 mA-Ausgang | x | x | x | x |

DK Montering af følerledninger
Ledninger monteres mellem metalpladerne. Ledningskvadrat (max.) 1x1.5 mm² flerkoret ledning. Klemmekruetspændingsmoment 0.4 Nm.

UK Mounting of sensor wires
wires must be mounted between the metal plates. Max. wire size 1x1.5 mm² stranded wire. Screw terminal torque 0.4 Nm.

FR Montage des fils du capteur
Les fils doivent être montés entre les plaques métalliques. Taille max. des fils 1x1.5 mm² fils multibrins. Pression max. avant déformation de la vis 0,4 Nm.

DE Montage von Fühlerleitungen
Die Leitungen müssen zwischen den Metallplatten montiert werden. Leitungsquerschnitt (max.) 1x1.5 mm² Litzen draht. Klemmschraubenanzugsmoment 0,4 Nm.

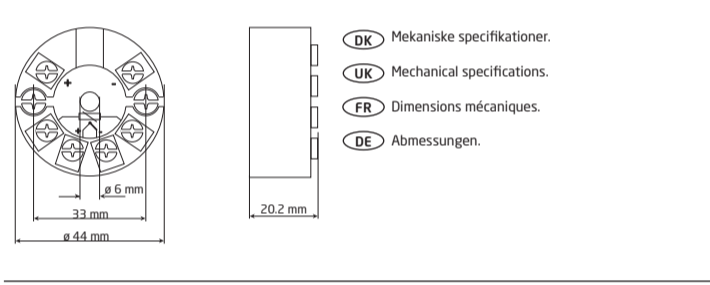

- DK** Dokumentation, godkendelser og yderligere information findes på internettet på www.prellectronics.dk
- UK** Documentation, permits and other information can be found on the internet at www.prellectronics.com
- FR** La documentation et toute autre information peuvent être trouvées sur l'Internet sur notre site: www.prellectronics.fr
- DE** Dokumentationen, Zulassungen und andere Informationen können auf unserer Internet-Seite unter www.prellectronics.de gefunden und abgerufen werden.
- BR** Documentações, licenças e outras informações podem ser encontradas no site www.prellectronics.com

DK Godkendelser UK Approvals FR Approbations DE Zulassungen BR Aprovações

| DK | ATEX | Area / Zone | Installation drawing | IECEX | Area / Zone | Installation drawing | FM | Zone / Div. | Installation drawing | CSA | Zone / Div. | Installation drawing | INMETRO | Area | Installation drawing | EAC Ex | PESO |
|-------|--------------------|---------------------|----------------------|--------------|---------------------|----------------------|-------------|--------------------|----------------------|---------|--------------------|----------------------|-----------------|---------------------|----------------------|-----------------------------|-----------|
| 5333A | DEKRA 20ATEX0106 X | 2, 22 | 5333QA02 | DEK 20.0062X | 2, 22 | 5333QI02 | | | | 1125003 | 2 / Div 2 | 5333QC02 | DEKRA 23.0010 X | 2, 22 | 5333QB02 | EAEU KZ 7500361.01.01.08756 | |
| 5343A | DEKRA 20ATEX0106 X | 2, 22 | 5343QA02 | DEK 20.0062X | 2, 22 | 5343QI02 | | | | | | | DEKRA 23.0010 X | 2, 22 | 5333QB02 | EAEU KZ 7500361.01.01.08756 | |
| 5333D | DEKRA 20ATEX0105 X | 0, 1, 2, 21, 22, M1 | 5333QA01 | DEK 20.0062X | 0, 1, 2, 21, 22, M1 | 5333QI01 | FM17US0013X | 0, 1, 2 / Div 1, 2 | 5300Q502 | 1125003 | 0, 1, 2 / Div 1, 2 | 5333QC03 | DEKRA 23.0010 X | 0, 1, 2, 21, 22, M1 | 5333QB01 | EAEU KZ 7500361.01.01.08756 | P658959/1 |
| 5343B | DEKRA 20ATEX0105 X | 0, 1, 2, 21, 22, M1 | 5343QA01 | DEK 20.0062X | 0, 1, 2, 21, 22, M1 | 5343QI01 | FM17US0013X | 0, 1, 2 / Div 1, 2 | 5300Q502 | | | | DEKRA 23.0010 X | 0, 1, 2, 21, 22, M1 | 5333QB01 | EAEU KZ 7500361.01.01.08756 | |

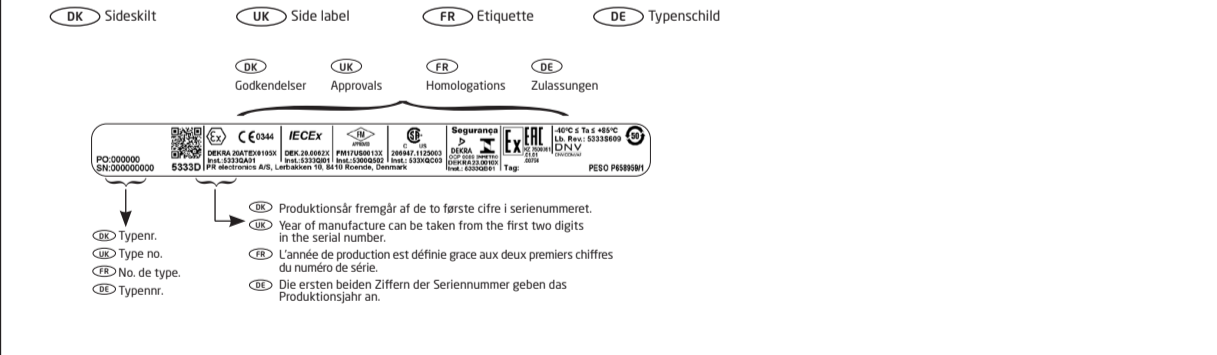
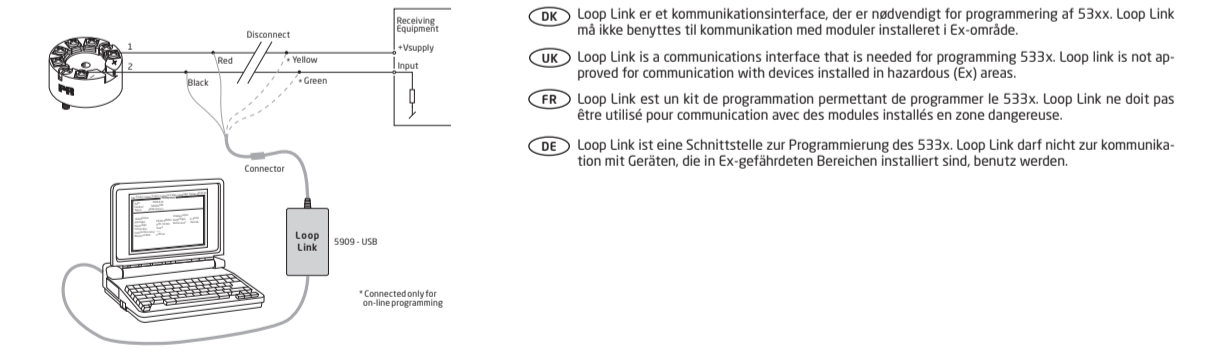

EU DECLARATION OF CONFORMITY (5333Dc_106)

As manufacturer
PR electronics A/S, Lerbakken 10, DK-8410 Rønde
hereby declares that the following product:
Type: 5333
Name: 2-wire programmable transmitter
From serial no.: 211809511
is in conformity with the following directives and standards:
The EMC Directive 2014/30/EU and later amendments: EN 61326-1:2013
Immunity test requirements for equipment intended to be used in an industrial electromagnetic environment. For specification of the acceptable EMC performance level, refer to the electrical specifications for the device.
The ATEX Directive 2014/34/EU and later amendments: EN IEC 60079-0:2018, EN 60079-7:2015 + A1:2018, EN 60079-11:2012 and EN 60079-25:2010
ATEX certificate: DEKRA 20ATEX0106 X (5333A)
ATEX certificate: DEKRA 20ATEX0105 X (5333D)
ATEX notified body (type approval): DEKRA Certification

ATEX-installation drawing 5333QA01-V3R0

For safe installation of 5333D the following must be observed. The module shall only be installed by qualified personnel who are familiar with the national and international laws, directives and standards that apply to this area. Year of manufacture can be taken from the first two digits in the serial number.

ATEX Certificate DEKRA 20ATEX0105 X
 Marking II 1 G Ex ia IIC T6...T4 Ga
 II 2 D Ex ia IIC Db
 I M1 Ex ia I Ma
 Standards EN 60079-0: 2018, EN 60079-11: 2012

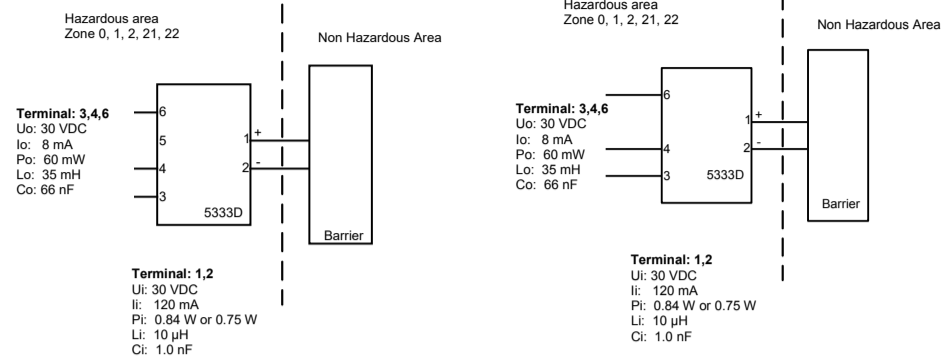

| Temperature Class | Ambient temperature range | |
|-------------------|---------------------------|----------------|
| | Pi: 0.84 W | Pi: 0.75 W |
| T6 | -40°C to +47°C | -40°C to +50°C |
| T5 | -40°C to +62°C | -40°C to +65°C |
| T4 | -40°C to +85°C | -40°C to +85°C |

Installation notes
 If the enclosure is made of non-metallic plastic materials, electrostatic charges on the transmitter enclosure shall be avoided.
 If the transmitter is installed in an explosive atmosphere requiring the use of equipment protection level Ga, the transmitter shall be mounted in an enclosure that provides a degree of protection of at least IP20 according to EN 60529, and that is suitable for the application and correctly installed.

If the transmitter is installed in an explosive atmosphere requiring the use of equipment protection level Ga or Ma, and if the enclosure is made of aluminum, it must be installed such that ignition sources due to impact and friction sparks are excluded.
 If the transmitter is installed in an explosive atmosphere requiring the use of equipment protection level Db, the transmitter shall be mounted in a separately certified enclosure that provides a degree of protection of at least IP5X according to EN 60079-0, and that is suitable for the application and correctly installed. The surface temperature of the outer enclosure is +20 K above the ambient temperature, determined without a dust layer. Ambient temperature range: -40°C to +85°C.

If the transmitter is installed in an explosive atmosphere requiring the use of equipment protection level Ma, the transmitter shall be mounted in an enclosure that provides a degree of protection of at least IP54 according to EN 60529, and that is suitable for the application and correctly installed. Ambient temperature range: -40°C to +85°C.

Cable entries and blanking elements shall be used that are suitable for the application and correctly installed.
 For an ambient temperature ≥ 60°C, heat resistant cables shall be used with a rating of at least 20 K above the ambient temperature.

ATEX-installation drawing 5333QA02-V3R0

For safe installation of 5333A the following must be observed. The module shall only be installed by qualified personnel who are familiar with the national and international laws, directives and standards that apply to this area. Year of manufacture can be taken from the first two digits in the serial number.

ATEX Certificate DEKRA 20ATEX0106 X
 Marking II 3 G Ex na [c] IIC T6...T4 Gc
 II 3 G Ex ec [c] IIC T6...T4 Gc
 II 3 D Ex ic IIC Dc
 Standards EN 60079-0: 2018, EN 60079-11: 2012, EN 60079-15: 2010, EN 60079-7: 2015 +A1: 2018

| Terminal 3,4,6 | Terminal 1,2 | Terminal 1,2 | Terminal 1,2 |
|---|---|---|--------------------------------------|
| Ex ic IIC, Ex ic IIC | Ex ic IIC, Ex ic IIC | Ex ic IIC, Ex ic IIC | Ex na, Ex ec |
| Uo: 5 V Io: 4 mA Po: 20 mW Li: 900 mH Co: 1000 µF | Ui = 35 V Ii = 110 mA Ci = 1 nF Li = 10 µH | Ui = 24 V Ii = 260 mA Ci = 1 nF Li = 10 µH | Umax ≤ 35 VDC or Umax ≤ 24 VDC |

| Ex ic IIC, Ex ic IIC Temperature Class | Ambient temperature range | |
|--|---------------------------|----------------|
| | Ui=35 V | Ui=24 V |
| T6 | -40°C to +54°C | -40°C to +63°C |
| T5 | -40°C to +69°C | -40°C to +78°C |
| T4 | -40°C to +85°C | -40°C to +85°C |

| Ex ec, Ex na Temperature Class | Ambient temperature range | |
|--------------------------------|---------------------------|----------------|
| | Vmax=35 V | Vmax=24 V |
| T6 | -40°C to +43°C | -40°C to +55°C |
| T5 | -40°C to +85°C | -40°C to +85°C |
| T4 | -40°C to +85°C | -40°C to +85°C |

Installation notes
 If the enclosure is made of non-metallic plastic materials, electrostatic charges on the transmitter enclosure shall be avoided.
 If the transmitter is installed in an explosive atmosphere requiring the use of equipment protection level Gc and applied in type of protection Ex ic, the transmitter shall be mounted in an enclosure that provides a degree of protection of at least IP20 according to EN 60529, and that is suitable for the application and correctly installed.

If the transmitter is installed in an explosive atmosphere requiring the use of equipment protection level Dc, the transmitter shall be mounted in a separately certified enclosure that provides a degree of protection of at least IP5X according to EN 60079-0, and that is suitable for the application and correctly installed. The surface temperature of the outer enclosure is +20 K above the ambient temperature, determined without a dust layer. Ambient temperature range: -40°C to +85°C.

If the transmitter is installed in an explosive atmosphere requiring the use of equipment protection level Gc and applied in type of protection Ex na or Ex ec, the transmitter shall be mounted in a separately certified enclosure that provides a degree of protection of at least IP54 according to EN 60079-0, and that is suitable for the application and correctly installed.

If the transmitter is installed in an explosive atmosphere requiring the use of equipment protection level Gc and applied in type of protection Ex na or Ex ec, the equipment shall only be used in an area of not more than pollution degree 2, as defined in EN 60664-1.

CSA Installation drawing 5333XC03 – V6R0

Hazardous area T4: -40 ≤ Ta ≤ 85°C
 T6: -40 ≤ Ta ≤ 60°C

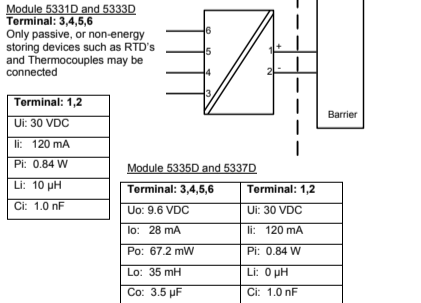

CLASS 2288 04 - PROCESS CONTROL EQUIPMENT - Intrinsically Safe Entry - For Hazardous Locations
CLASS 2288 84 - PROCESS CONTROL EQUIPMENT - Intrinsically Safe Entry - For Hazardous Locations - Certified to US Standards

Class I, Division 1, Groups A, B, C and D T6...T4
 Ex ia IIC T6...T4 Ga
 Class I, Zone 0, AEx ia IIC Ga
Warning:
 Substitution of components may impair intrinsic safety.

The transmitters must be installed in a suitable enclosure to meet installation codes stipulated in the Canadian Electrical Code (CEC) or for US the National Electrical Code (NEC).

WARNING: Substitution of components may impair suitability for Class I, Division 2
 AVERTISSEMENT: la substitution de composants peut nuire à l'aptitude à la Classe I, Division 2.
 WARNING: Do not disconnect equipment unless power has been switched off or the area is known to be safe.
 AVERTISSEMENT: Ne débranchez pas l'équipement sauf si l'alimentation a été coupée ou si la zone est connue pour être sûre.

Non Incendive field wiring installation
 The non incandive field Wiring Circuit concept allows interconnection of Nonincendive Field wiring Apparatus with Associated Nonincendive Field Wiring Apparatus or Associated Intrinsically Safe Apparatus or Associated Apparatus not specially examined in combination as a system using any of the wiring methods permitted for unclassified locations.
 Uoc < Vmax, Ca ≥ Ci + Ccable, La ≥ Li + Lcable.

DK Kina RoHS UK China RoHS FR RoHS chinois DE China-RoHS

| Part Name | Hazardous Substances | | | | |
|-----------------------|----------------------|--------------|--------------|-------------------------------|---------------------------------------|
| | Lead (Pb) | Mercury (Hg) | Cadmium (Cd) | Hexavalent Chromium (Cr (VI)) | Polybrominated diphenyl ethers (PBDE) |
| Printed circuit board | X | 0 | 0 | 0 | 0 |

This table is prepared in accordance with the provisions of 5/17 11364
 0: Indicates that said hazardous substance contained in all of the homogeneous materials for this part is below the limit requirement of GB/T 26572.
 X: Indicates that said hazardous substance contained in at least one of the homogeneous materials used for this part is above the limit requirement of GB/T 26572.

The product's Environmentally Friendly Use Period (EFUP) is 50 years

IECEx-installation drawing 5333QI01-V3R0

For safe installation of 5333D the following must be observed. The module shall only be installed by qualified personnel who are familiar with the national and international laws, directives and standards that apply to this area. Year of manufacture can be taken from the first two digits in the serial number.

Certificate IECEx DEK 20.0062X
 Marking Ex ia IIC T6...T4 Ga
 Ex ia IIC Db
 Ex ia I Ma
 Standards IEC 60079-0: 2017, IEC 60079-11: 2011

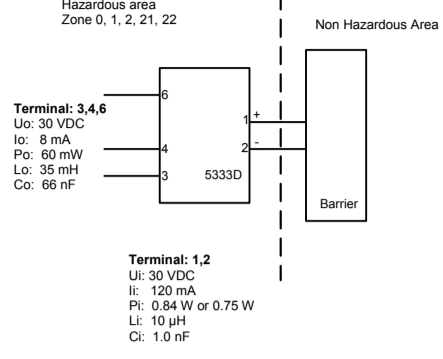

| Temperature Class | Ambient temperature range | |
|-------------------|---------------------------|----------------|
| | Pi: 0.84 W | Pi: 0.75 W |
| T6 | -40°C to +47°C | -40°C to +50°C |
| T5 | -40°C to +62°C | -40°C to +65°C |
| T4 | -40°C to +85°C | -40°C to +85°C |

Installation notes
 If the enclosure is made of non-metallic plastic materials, electrostatic charges on the transmitter enclosure shall be avoided.
 If the transmitter is installed in an explosive atmosphere requiring the use of equipment protection level Ga, the transmitter shall be mounted in an enclosure that provides a degree of protection of at least IP20 according to IEC 60529, and that is suitable for the application and correctly installed.

If the transmitter is installed in an explosive atmosphere requiring the use of equipment protection level Ga or Ma, and if the enclosure is made of aluminum, it must be installed such that ignition sources due to impact and friction sparks are excluded.
 If the transmitter is installed in an explosive atmosphere requiring the use of equipment protection level Db, the transmitter shall be mounted in a separately certified enclosure that provides a degree of protection of at least IP5X according to IEC 60079-0, and that is suitable for the application and correctly installed. The surface temperature of the outer enclosure is +20 K above the ambient temperature, determined without a dust layer. Ambient temperature range: -40°C to +85°C.

If the transmitter is installed in an explosive atmosphere requiring the use of equipment protection level Ma, the transmitter shall be mounted in an enclosure that provides a degree of protection of at least IP54 according to IEC 60529, and that is suitable for the application and correctly installed. Ambient temperature range: -40°C to +85°C.

Cable entries and blanking elements shall be used that are suitable for the application and correctly installed.
 For an ambient temperature ≥ 60°C, heat resistant cables shall be used with a rating of at least 20 K above the ambient temperature.

IECEx-installation drawing 5333QI02-V3R0

For safe installation of 5333A the following must be observed. The module shall only be installed by qualified personnel who are familiar with the national and international laws, directives and standards that apply to this area. Year of manufacture can be taken from the first two digits in the serial number.

Certificate IECEx DEK 20.0062X
 Marking Ex na [c] IIC T6...T4 Gc
 Ex ec [c] IIC T6...T4 Gc
 Ex ic IIC T6...T4 Gc
 Ex ic IIC Dc
 Standards IEC 60079-0: 2017, IEC 60079-11: 2011, IEC 60079-15: 2010, IEC 60079-7: 2017

| Terminal 3,4,5,6 | Terminal 1,2 | Terminal 1,2 | Terminal 1,2 |
|---|---|---|--------------------------------------|
| Ex ic IIC, Ex ic IIC | Ex ic IIC, Ex ic IIC | Ex ic IIC, Ex ic IIC | Ex na, Ex ec |
| Uo: 5 V Io: 4 mA Po: 20 mW Li: 900 mH Co: 1000 µF | Ui = 35 V Ii = 110 mA Ci = 1 nF Li = 10 µH | Ui = 24 V Ii = 260 mA Ci = 1 nF Li = 10 µH | Umax ≤ 35 VDC or Umax ≤ 24 VDC |

| Ex ic IIC, Ex ic IIC Temperature Class | Ambient temperature range | |
|--|---------------------------|----------------|
| | Ui=35 V | Ui=24 V |
| T6 | -40°C to +54°C | -40°C to +63°C |
| T5 | -40°C to +69°C | -40°C to +78°C |
| T4 | -40°C to +85°C | -40°C to +85°C |

| Ex ec, Ex na Temperature Class | Ambient temperature range | |
|--------------------------------|---------------------------|----------------|
| | Vmax=35 V | Vmax=24 V |
| T6 | -40°C to +43°C | -40°C to +55°C |
| T5 | -40°C to +85°C | -40°C to +85°C |
| T4 | -40°C to +85°C | -40°C to +85°C |

Installation notes
 If the enclosure is made of non-metallic plastic materials, electrostatic charges on the transmitter enclosure shall be avoided.
 If the transmitter is installed in an explosive atmosphere requiring the use of equipment protection level Gc and applied in type of protection Ex ic, the transmitter shall be mounted in an enclosure that provides a degree of protection of at least IP20 according to IEC 60529, and that is suitable for the application and correctly installed.

If the transmitter is installed in an explosive atmosphere requiring the use of equipment protection level Dc, the transmitter shall be mounted in a separately certified enclosure that provides a degree of protection of at least IP5X according to IEC 60079-0, and that is suitable for the application and correctly installed. The surface temperature of the outer enclosure is +20 K above the ambient temperature, determined without a dust layer. Ambient temperature range: -40°C to +85°C.

If the transmitter is installed in an explosive atmosphere requiring the use of equipment protection level Gc and applied in type of protection Ex na or Ex ec, the transmitter shall be mounted in a separately certified enclosure that provides a degree of protection of at least IP54 according to IEC 60079-0, and that is suitable for the application and correctly installed.

If the transmitter is installed in an explosive atmosphere requiring the use of equipment protection level Gc and applied in type of protection Ex na or Ex ec, the equipment shall only be used in an area of not more than pollution degree 2, as defined in IEC 60664-1.

CSA Installation drawing 5333QC02 – V2R0

For safe installation of the 5333A the following must be observed. The module shall only be installed by qualified personnel who are familiar with the national and international laws, directives and standards that apply to this area.

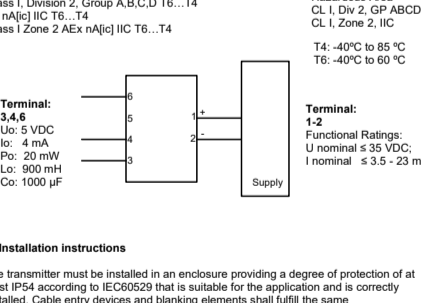

Non Incendive field wiring installation
 The non incandive field Wiring Circuit concept allows interconnection of Nonincendive Field wiring Apparatus with Associated Nonincendive Field Wiring Apparatus or Associated Intrinsically Safe Apparatus or Associated Apparatus not specially examined in combination as a system using any of the wiring methods permitted for unclassified locations.
 Uoc < Vmax, Ca ≥ Ci + Ccable, La ≥ Li + Lcable.

DK Kina RoHS UK China RoHS FR RoHS chinois DE China-RoHS

| Part Name | Hazardous Substances | | | | |
|-----------------------|----------------------|--------------|--------------|-------------------------------|---------------------------------------|
| | Lead (Pb) | Mercury (Hg) | Cadmium (Cd) | Hexavalent Chromium (Cr (VI)) | Polybrominated diphenyl ethers (PBDE) |
| Printed circuit board | X | 0 | 0 | 0 | 0 |

This table is prepared in accordance with the provisions of 5/17 11364
 0: Indicates that said hazardous substance contained in all of the homogeneous materials for this part is below the limit requirement of GB/T 26572.
 X: Indicates that said hazardous substance contained in at least one of the homogeneous materials used for this part is above the limit requirement of GB/T 26572.

The product's Environmentally Friendly Use Period (EFUP) is 50 years

ATEX-installation drawing 5343QA01-V3R0

For safe installation of 5343B the following must be observed. The module shall only be installed by qualified personnel who are familiar with the national and international laws, directives and standards that apply to this area. Year of manufacture can be taken from the first two digits in the serial number.

ATEX Certificate DEKRA 20ATEX0105 X
 Marking II 1 G Ex ia IIC T6...T4 Ga
 II 2 D Ex ia IIC Db
 I M1 Ex ia I Ma
 Standards EN 60079-0: 2018, EN 60079-11: 2012

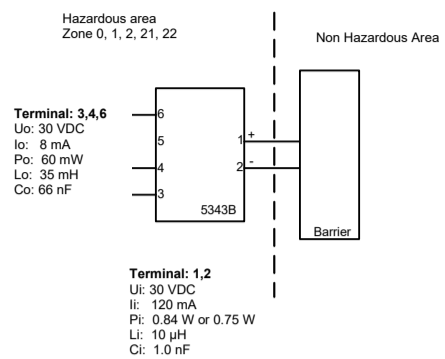

| Temperature Class | Ambient temperature range | |
|-------------------|---------------------------|----------------|
| | Pi: 0.84 W | Pi: 0.75 W |
| T6 | -40°C to +47°C | -40°C to +50°C |
| T5 | -40°C to +62°C | -40°C to +65°C |
| T4 | -40°C to +85°C | -40°C to +85°C |

Installation notes
 If the enclosure is made of non-metallic plastic materials, electrostatic charges on the transmitter enclosure shall be avoided.
 If the transmitter is installed in an explosive atmosphere requiring the use of equipment protection level Ga, the transmitter shall be mounted in an enclosure that provides a degree of protection of at least IP20 according to EN 60529, and that is suitable for the application and correctly installed.

If the transmitter is installed in an explosive atmosphere requiring the use of equipment protection level Ga or Ma, and if the enclosure is made of aluminum, it must be installed such that ignition sources due to impact and friction sparks are excluded.
 If the transmitter is installed in an explosive atmosphere requiring the use of equipment protection level Db, the transmitter shall be mounted in a separately certified enclosure that provides a degree of protection of at least IP5X according to EN 60079-0, and that is suitable for the application and correctly installed. The surface temperature of the outer enclosure is +20 K above the ambient temperature, determined without a dust layer. Ambient temperature range: -40°C to +85°C.

If the transmitter is installed in an explosive atmosphere requiring the use of equipment protection level Ma, the transmitter shall be mounted in an enclosure that provides a degree of protection of at least IP54 according to EN 60529, and that is suitable for the application and correctly installed. Ambient temperature range: -40°C to +85°C.

Cable entries and blanking elements shall be used that are suitable for the application and correctly installed.
 For an ambient temperature ≥ 60°C, heat resistant cables shall be used with a rating of at least 20 K above the ambient temperature.

ATEX-installation drawing 5343QA02-V3R0

For safe installation of 5343A the following must be observed. The module shall only be installed by qualified personnel who are familiar with the national and international laws, directives and standards that apply to this area. Year of manufacture can be taken from the first two digits in the serial number.

ATEX Certificate DEKRA 20ATEX0106 X
 Marking II 3 G Ex na [c] IIC T6...T4 Gc
 II 3 G Ex ec [c] IIC T6...T4 Gc
 II 3 D Ex ic IIC Dc
 Standards EN 60079-0: 2018, EN 60079-11: 2012, EN 60079-15: 2010, EN 60079-7: 2015 +A1: 2018

| Terminal 3,4,6 | Terminal 1,2 | Terminal 1,2 | Terminal 1,2 |
|---|---|---|--------------------------------------|
| Ex ic IIC, Ex ic IIC | Ex ic IIC, Ex ic IIC | Ex ic IIC, Ex ic IIC | Ex na, Ex ec |
| Uo: 5 V Io: 4 mA Po: 20 mW Li: 900 mH Co: 1000 µF | Ui = 35 V Ii = 110 mA Ci = 1 nF Li = 10 µH | Ui = 24 V Ii = 260 mA Ci = 1 nF Li = 10 µH | Umax ≤ 35 VDC or Umax ≤ 24 VDC |

| Ex ic IIC, Ex ic IIC Temperature Class | Ambient temperature range | |
|--|---------------------------|----------------|
| | Ui=35 V | Ui=24 V |
| T6 | -40°C to +54°C | -40°C to +63°C |
| T5 | -40°C to +69°C | -40°C to +78°C |
| T4 | -40°C to +85°C | -40°C to +85°C |

| Ex ec, Ex na Temperature Class | Ambient temperature range | |
|--------------------------------|---------------------------|----------------|
| | Vmax=35 V | Vmax=24 V |
| T6 | -40°C to +43°C | -40°C to +55°C |
| T5 | -40°C to +85°C | -40°C to +85°C |
| T4 | -40°C to +85°C | -40°C to +85°C |

Installation notes
 If the enclosure is made of non-metallic plastic materials, electrostatic charges on the transmitter enclosure shall be avoided.
 If the transmitter is installed in an explosive atmosphere requiring the use of equipment protection level Gc and applied in type of protection Ex ic, the transmitter shall be mounted in an enclosure that provides a degree of protection of at least IP20 according to EN 60529, and that is suitable for the application and correctly installed.

If the transmitter is installed in an explosive atmosphere requiring the use of equipment protection level Dc, the transmitter shall be mounted in a separately certified enclosure that provides a degree of protection of at least IP5X according to EN 60079-0, and that is suitable for the application and correctly installed. The surface temperature of the outer enclosure is +20 K above the ambient temperature, determined without a dust layer. Ambient temperature range: -40°C to +85°C.

If the transmitter is installed in an explosive atmosphere requiring the use of equipment protection level Gc and applied in type of protection Ex na or Ex ec, the transmitter shall be mounted in a separately certified enclosure that provides a degree of protection of at least IP54 according to EN 60079-0, and that is suitable for the application and correctly installed.

If the transmitter is installed in an explosive atmosphere requiring the use of equipment protection level Gc and applied in type of protection Ex na or Ex ec, the equipment shall only be used in an area of not more than pollution degree 2, as defined in EN 60664-1.

Desenho de Instalação INMETRO 5333QB02-V3R0

Para instalação segura do 5343A o seguinte deve ser observado. O modelo deve apenas ser instalado por pessoas qualificadas que são familiarizadas com as leis nacionais e internacionais, diretivas e padrões que se aplicam a esta área.
 Ano de fabricação pode ser pegado dos dois primeiros dígitos do número de série

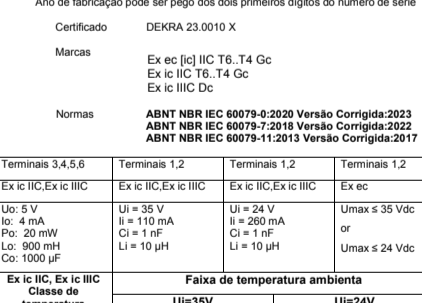

Non Incendive field wiring installation
 The non incandive field Wiring Circuit concept allows interconnection of Nonincendive Field wiring Apparatus with Associated Nonincendive Field Wiring Apparatus or Associated Intrinsically Safe Apparatus or Associated Apparatus not specially examined in combination as a system using any of the wiring methods permitted for unclassified locations.
 Uoc < Vmax, Ca ≥ Ci + Ccable, La ≥ Li + Lcable.

DK Kina RoHS UK China RoHS FR RoHS chinois DE China-RoHS

| Part Name | Hazardous Substances | | | | |
|-----------------------|----------------------|--------------|--------------|-------------------------------|---------------------------------------|
| | Lead (Pb) | Mercury (Hg) | Cadmium (Cd) | Hexavalent Chromium (Cr (VI)) | Polybrominated diphenyl ethers (PBDE) |
| Printed circuit board | X | 0 | 0 | 0 | 0 |

This table is prepared in accordance with the provisions of 5/17 11364
 0: Indicates that said hazardous substance contained in all of the homogeneous materials for this part is below the limit requirement of GB/T 26572.
 X: Indicates that said hazardous substance contained in at least one of the homogeneous materials used for this part is above the limit requirement of GB/T 26572.

The product's Environmentally Friendly Use Period (EFUP) is 50 years

IECEx-installation drawing 5343QI01-V3R0

For safe installation of 5343B the following must be observed. The module shall only be installed by qualified personnel who are